



Aplus, Reliable Power Brand Deserve Your Trust

USER'S MANUAL



Content

1. Safety Instructions	1
1.1 Transport.....	1
1.2 Set-up.....	1
1.3. Installation.....	1
1.4 Operation	2
1.5 Maintenance, servicing and faults.....	2
2. Description of Commonly Used Notations	4
3. Introduction	5
3.1 Functions description	5
3.2 Product specification and performance	6
3.3 Typical backup time	7
3.4 Unpacking and inspection.....	7
3.5 Input & output power cords & protective earth ground installation.....	8
3.6 Operating procedure for connecting the long backup time model UPS with the external battery	13
3.7 EPO (Emergency Power Off) connection.....	15
4. Rear View	16
4.1 Tower model.....	16
4.2 Rackmount model.....	18
5. Operation	21
5.1 Display panel.....	21
5.2 Operating mode.....	24
5.3 Turning on and turning off UPS.....	30
5.4 LCD operation	31
5.5 Remove main UPS from UPS system for maintenance.....	44
6. Special Functions	49
6.1 HE (High Efficiency) function.....	49
6.2 Converter function.....	50
6.3 Parallel function (Rackmount model available)	50
7. Trouble Shooting	54
7.1 Trouble shooting according to warning indication.....	54
7.2 Trouble shooting according to warning indication (Available for rackmount model in parallel connection).....	55
7.3 Trouble shooting according to fault indication.....	56
7.4 Trouble shooting according to fault indication (Available for rackmount model in parallel connection)	57
7.5 Trouble shooting in else cases.....	57
8. Battery Maintenance	58
9. Communication Port	59
9.1 USB interface.....	59
9.2 Dry contact interface.....	59
9.3 Intelligent slot.....	59
10. Monitoring Software	60
10.1 Free software download – WinPower	60
10.2 Installation procedure.....	60

1. Safety Instructions

Please read the following content and safety instructions before installation or operation.

1.1 Transport

Please transport the UPS system only in the original packaging to protect against shock and impact during transportation.

1.2 Set-up

 Condensation may occur if the UPS system is moved directly from a cold to a warm environment. The UPS system must be absolutely dry before being installed. Please allow an acclimatization time of at least two hours.

 Do not install the UPS system near water or in damp environments.

 Do not install the UPS system where it would be exposed to direct sunlight or near heat.

 Do not block off ventilation openings in the UPS system's housing.

1.3 Installation

 Do not connect appliances or items of equipment which would overload the UPS system (e.g. laser printers) to the UPS output terminals or sockets.

Place cables in such a way that no one can step on or trip over them.

 **Warning:** This is a product for restricted sales distribution to informed partners. Installation restrictions or additional measures may be needed to prevent disturbances.

 A readily accessible disconnect device shall be incorporated in the building of installation wiring and must be close to the UPS system.

 This is permanently connected equipment and only qualified maintenance personnel may carry out installations.

1.4 Operation

 Do not disconnect the mains cable on the UPS system or the building wiring socket during operations since this would cancel the protective grounding of the UPS system and of all connected loads.

 The UPS system features its own internal current source (batteries). The UPS output terminals block or output socket may be electrically lived even if the UPS system is not connected to the building wiring socket.

 In order to fully disconnect the UPS system, first press the Standby switch then disconnect the mains lead.

 Ensure that no fluids or other foreign objects can enter the UPS system.

 Do not remove the enclosure. This UPS system is to be serviced by qualified service personnel only.

1.5 Maintenance, Servicing and Faults

 The UPS system operates with hazardous voltages. Repairs may be carried out only by qualified maintenance personnel.

 Caution - risk of electric shock. Even after the unit is disconnected from the mains power supply (building wiring socket), components inside the UPS system are still connected to the battery and are still electrically live and dangerous.

 Before carrying out any kind of servicing and/or maintenance, disconnect the batteries and verify that no current is present, and no hazardous voltage exists in the terminals of high capability capacitor such as BUS-capacitors.

 Only persons are adequately familiar with batteries and with the required precautionary measures may replace batteries and supervise operations. Unauthorised persons must be kept well away from the batteries.

 Caution - risk of electric shock. The battery circuit is not isolated from the input voltage. Hazardous voltages may occur between the battery terminals and the ground. Before touching, please verify that no voltage is present!

 Batteries may cause electric shock and have a high short-circuit current. Please take the precautionary measures specified below and any other measures necessary when working with batteries:

- 1) Remove wrist watches, rings and other metal objects
- 2) Use only tools with insulated grips and handles.

 When change batteries, install the same quantity and same type of batteries.











 Do not attempt to dispose of batteries by burning them. This could cause battery explosion. Do not open or destroy batteries. Escaping electrolyte can cause injury to the skin and eyes. It may be toxic.

 Please replace the fuse only by a fuse of the same type and of the same amperage in order to avoid fire hazards.

 Do not dismantle the UPS system.

2. Description of Commonly Used Notations

Some or all of the following notations may be used in this manual and may appear in your application process. Therefore, all users should be familiar with them and understand their explanations.

Nation and Explanation			
Nation	Explanation	Nation	Explanation
	Alert you to pay special attention		Protective ground
	Caution of high voltage		Overload indication
	ON/OFF		Bypass
	Alternating current source (AC)		Inverter
	Direct current source (DC)		Do not dispose with ordinary trash
	Battery		

3. Introduction

3.1 Functions description

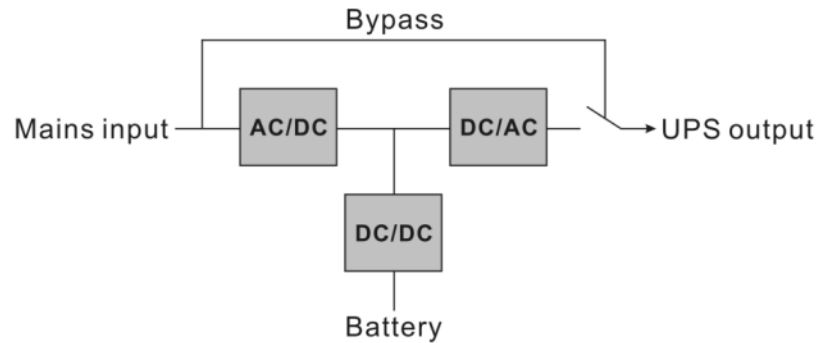

This product is a true online double-conversion UPS (Uninterruptible Power Supply). It provides perfect protection for critical load such as computer system. It can eliminate almost all mains power disturbances. The input AC current can be corrected to a wave following the mains voltage, so it is a high power factor system. Through the PWM control technology, the output voltage can be a pure & stable sine wave AC voltage.

When the mains input become abnormal, the controller will stop the AC/DC and start the DC/DC section immediately to make sure the DC/AC (inverter) section can continue to work. After the mains input comeback to normal range, the DC/DC will be stopped and the AC/DC works again. So the load is always power-supplied through inverter without any interrupt if the UPS is turned on.

The UPS also provides an internal bypass way to make the load can be powered by mains input directly when the UPS is off or failed.

The UPS have an internal charger for batteries, the charger will charge the batteries when the mains is in a reasonable range on “bypass mode” or “line mode”.

3.2 Product specification and performance

1) General specification

Model	6KVA	10KVA
INPUT		
Phase	Single	
Voltage	176~276VAC	
Frequency	45 ~ 55Hz @ 50Hz system 54 ~ 66Hz @ 60Hz system	
Normal current (@230V/battery recharged fully)	26A	43.5A
THDI	< 5% @ full load	
Power factor	≥0.99 @ full load	
OUTPUT		
Power rating	6KVA/5.4KW	10KVA/9KW
Voltage	1P2W+G, 208/220/230/240VAC	
The load capacity would be derated to 90% automatically when the output voltage is adjusted to 208VAC.		
Voltage (W/ ISO TRF)	1P3W+G, 110/220VAC or 115/230VAC or 120/240VAC	
Frequency (Battery mode)	50Hz or 60Hz ±0.05Hz	
Wave form	Pure sinewave	
Load type	PF 0.5 ~ 1, lagging	
THD	< 2% @ full linear load < 5% @ full non-linear load	
Overload	<u>Line mode</u> 10 min @ 105~125% 1 min @ 125~150% 10 s @ >150% 100 ms @ >170%	
	The overload capacity would be derated automatically in Line mode while the circumstance temperature is higher than 35 degree.	
	<u>Battery mode</u> 2 min @ 105~125% 30 s @ 125~150% 100 S @ >150%	

2) Operating environment

Operating temperature	0 °C to 45 °C
Operating humidity	< 95%
Altitude	< 1000m The load capacity should be derated 1% every 100m heightened on the basis of 1000m.
Storage temperature	-15 °C to 50 °C

3.3 Typical backup time (at 25°C)

Model No.	100 % Load
6KVA	5.2 minutes
10KVA	3.9 minutes

3.4 Unpacking and inspection

Inspect the appearance of the UPS to see if there is any damage during transportation. Do not turn on the unit and notify the carrier and dealer immediately if there is any damage or lacking of some parts.

3.5 Input & output power cords & protective earth ground installation

3.5.1 Notes for installation

- 1) The UPS must be installed in a location with good ventilation, far away from water, inflammable gas and corrosive agents.
- 2) Ensure the air vents on the front and rear of the UPS are not blocked. Allow at least 0.5m of space on each side.
- 3) Condensation to water drops may occur if the UPS is unpacked in a very low temperature environment. In this case it is necessary to wait until the UPS is fully dried inside out before proceeding installation and use. Otherwise there are hazards of electric shock.

3.5.2 Installation

Installation and wiring must be performed in accordance with the local electric code and the following instructions by professional personnel.

For safety, please cut off the mains power switch before installation. The battery breaker also needs to be cut off if UPS is connected with external battery bank.

- 1) Open the terminal block cover located on the rear panel of the UPS.
- 2) For 6KVA UPS, it is recommended to select the UL1015 8AWG(6mm²) wire or other insulated wire which complies with AWG Standard for the UPS input and output wirings.
- 3) For 10KVA, it is recommended to select the UL1015 6AWG(10mm²) wire or other insulated wire which complies with AWG Standard for the UPS input and output wirings.

Note: Do not use the wall receptacle as the input power source for the UPS, as its rated current is less than the UPS's maximum input current. Otherwise the receptacle may be burned and destroyed.

Tower Model:

Connect the input and output wires to the corresponding input and output terminals according to the following diagram.

(1) Input/Output: 1P2W+G, 208/220/230/240VAC

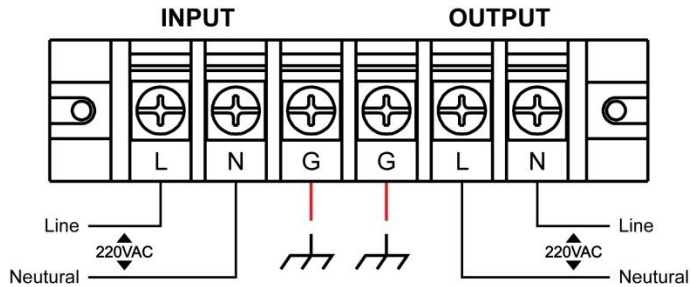

(2) Input: 1P2W+G, 220/230/240VAC ; Output: 1P3W+G, 110/220VAC or 115/230VAC or 120/240VAC

➤ Connection for dual output: 110/220VAC or 115/230VAC or 120/240VAC

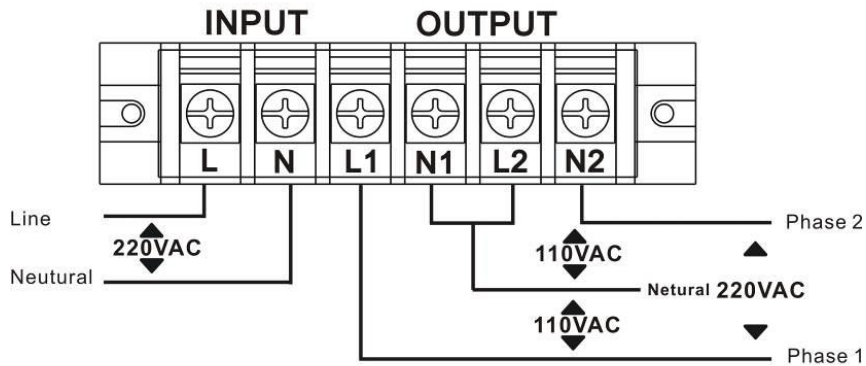

➤ Connection for single output: 110VAC or 115VAC or 120VAC

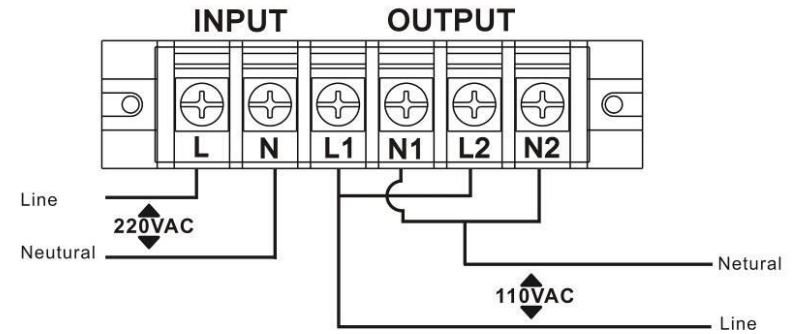

Note: Please make sure that the input and output wires and the input and output terminals are connected tightly.

Rackmount Model:

(1) Input/Output: 1P2W+G, 208/220/230/240VAC

UPS model with PDU module and input and output terminal block is on PDU module.

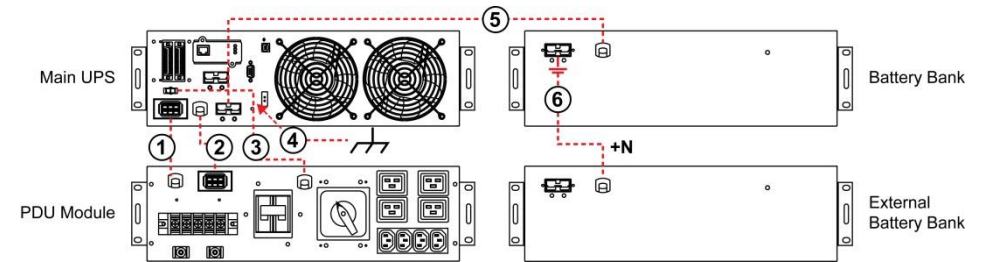

- ① Connection for UPS AC Input
- ② Connection for UPS AC Output
- ③ Connection for Bypass
- ④ Connection for Safety Ground
- ⑤ Connection for External Battery Bank
- ⑥ Connection for Extra External Battery Bank (Long Backup Time Model)

Connect the input and output wires to the corresponding input and output terminals according to the following diagram.

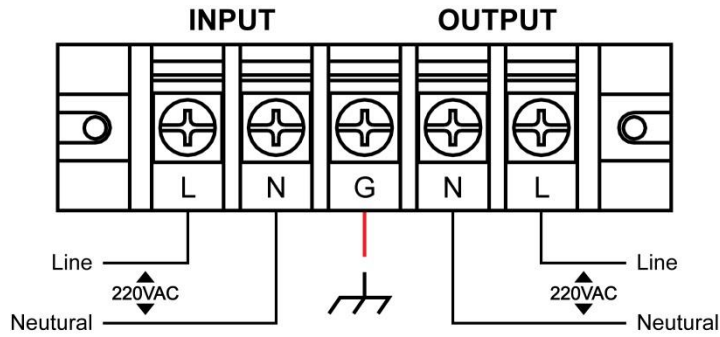

(2) Input: 1P2W+G, 220/230/240VAC ; Output: 1P3W+G, 110/220VAC or 115/230VAC or 120/240VAC

UPS model without PDU module and input and output terminal block is on isolation transformer rack box.

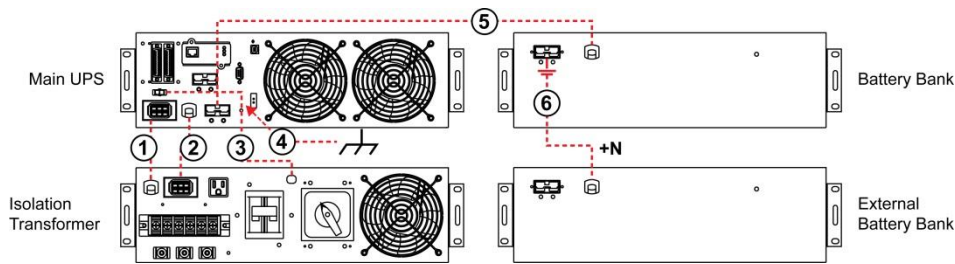

- ① Connection for UPS AC Input
- ② Connection for UPS AC Output
- ③ Connection for Bypass
- ④ Connection for Safety Ground
- ⑤ Connection for External Battery Bank
- ⑥ Connection for Extra External Battery Bank (Long Backup Time Model)

Connect the input and output wires to the corresponding input and output terminals according to the following diagram.

➤ Connection for dual output: 110/220VAC or 115/230VAC or 120/240VAC

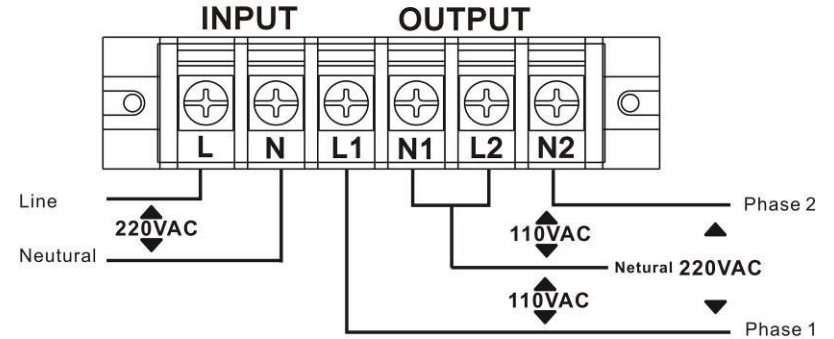

➤ Connection for single output: 110VAC or 115VAC or 120VAC

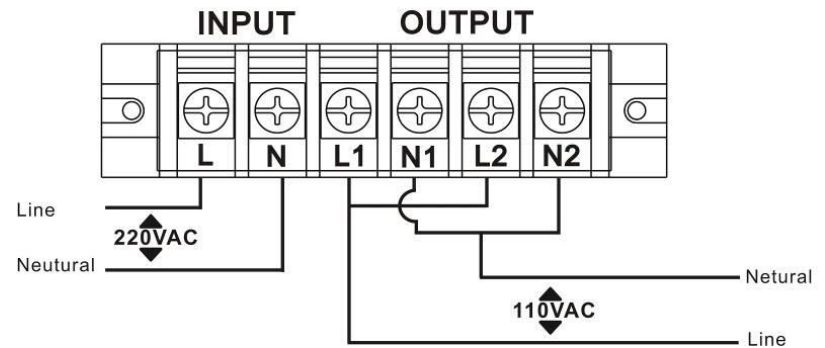

Note:

Please make sure that the input and output wires and the input and output terminals are connected tightly.

If UPS is used in single mode, JP1 and JP2 must be connected by 10AWG(6mm²) ; If UPS is used in parallel mode, the connector between JP1 and JP2 must be removed. Read Chapter 6.3 for detail information.

- 4) After having completed the installation, make sure the wiring is correct.
- 5) Please install the leak current protective breaker at the output power distribution panel of the UPS if necessary.
- 6) To connect the load with the UPS, please turn off all the loads first, then perform the connection and finally turn on the loads one by one.
- 7) No matter the UPS is connected to the utility power or not, the output of the UPS may have electricity. The parts inside the unit may still have hazardous voltage after turning off the UPS. To make the UPS have no output, power off the UPS, and then disconnect the utility power supply.
- 8) It is suggested to charge batteries for 8 hours before use. After connection, turn the input breaker to the "ON" position, and then UPS will charge batteries automatically. You can also use the UPS immediately without charging the batteries first, but the backup time may be less than the standard value.
- 9) If it is necessary to connect the inductance load such as a monitor or a laser printer to the UPS, the start-up power should be used for calculating the capacity of the UPS, as its start-up power consumption is too big when it is started.

3.6 Operating procedure for connecting the long backup time model UPS with the external battery

- 1) The nominal DC voltage of external battery pack is 240VDC. Each battery pack consists of 20 pieces of 12V maintenance free batteries in series. To achieve longer backup time, it is possible to connect multi-battery packs, but the principle of "same voltage, same type" should be strictly followed.

- 2) The connector of the external battery cable is used to plug into the external battery socket of the UPS, the other end of the external battery cable is connected to the external battery pack(s). The procedure of installing battery bank should be complied with strictly. Otherwise you may encounter the hazardous of electric shock.

(1) A DC breaker must be connected between the battery pack and the UPS. The capacity of breaker must be not less than the data specified in the general specification.

Model	6KVA	10KVA
Fuse/Breaker	32A/240VDC	50A/240VDC

(2) Set the battery pack breaker in "OFF" position and connect the 20 pieces of batteries in series.

(3) You must connect the external battery cable to the battery first. If you connect the cable to the UPS first, you may encounter the hazardous of electric shock.

(4) Please prepare the external battery cable that should be able to carry the current of >32A for 6KVA, and >50A for 10KVA, the cross section area should be greater than 10mm²(6AWG) for all model. And battery wire color is recommended as following:

+	GND	-
Red wire	Yellow/Green wire	Black wire

(5) The positive pole of the battery is connected to the UPS in parallel with red wires; the negative pole of the battery is connected to the UPS in parallel with black wires; the green and yellow ribbon wire is connected to the ground of the battery cabinet.

3) To complete the connection by plugging the connector of the external battery cable into the external battery socket of the UPS. Do not attempt to connect any loads to the UPS now. You should connect the input power wire to the right position first, and then set the breaker of the battery pack in the "ON" position. After that set the input breaker in the "ON" position, the UPS begins to charge the battery packs at the time.

3.7 EPO (Emergency Power Off) connection

3.7.1 Introduction

Emergency power off function which the UPS supplies is, when the emergency occurs, such as the failure of load, the UPS can cut off the output at once by operating the EPO port manually.

3.7.2 The connection

Normally the EPO connector is closed with a wire on the rear panel, which is supplied in the accessory. Once the connector is open, the UPS would stop the output and enter EPO status.

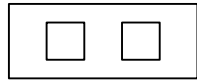

Enable the EPO status

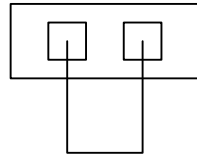

Disable the EPO status

To recover to normal status, first EPO connector should be closed, and enter LCD menu (illustrated in the chapter of 5.4.5) to clear EPO status, then UPS would stop alarm and recover to Bypass mode. And UPS needs be turned on by manual operation.

The polarity of connector could be inverted by setting in LCD menu in the chapter of 5.4.7. Contact your local distributor for further information before modifying the settings.

4. Rear View

4.1 Tower model:

◆ Main UPS Box

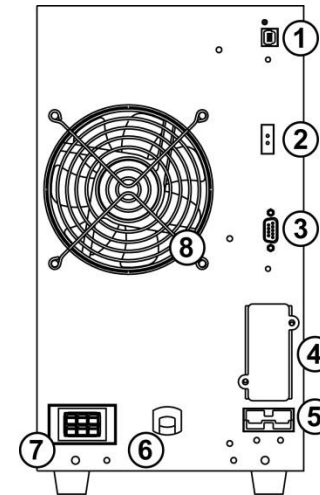

6KVA

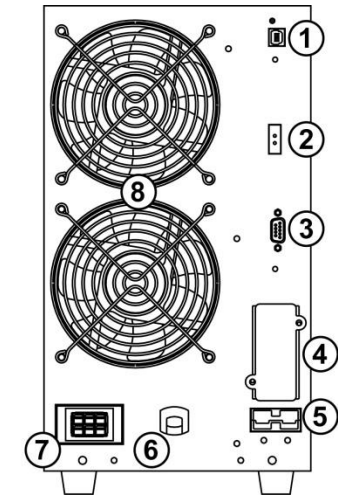

10KVA

- ① Communication Port: USB port
- ② EPO Port
- ③ Dry Contact
- ④ Intelligent Slot
- ⑤ External Battery Connector: 240VDC
- ⑥ UPS AC Output Connection Cable
- ⑦ UPS AC Input Connector
- ⑧ Cooling Fan

◆ **Battery Bank Box**

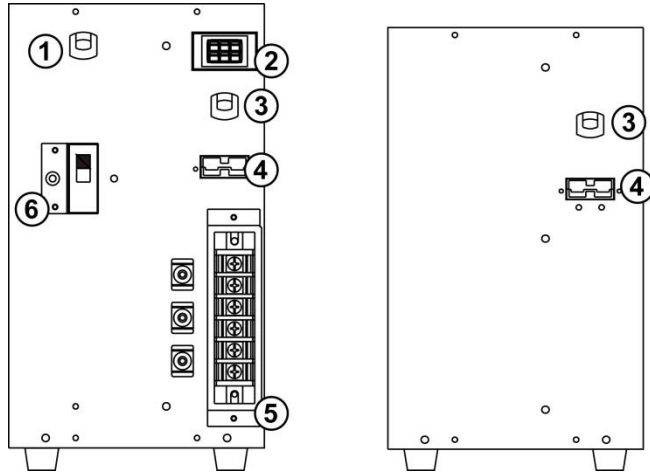

- ① UPS AC Input Connection Cable
- ② UPS AC Output Connector
- ③ External Battery Bank Connection Cable: 240VDC
- ④ Battery Bank Connector: 240VDC
- ⑤ Input/Output Terminal of PDU Module
- ⑥ Input Breaker

◆ **Isolation Transformer Box**

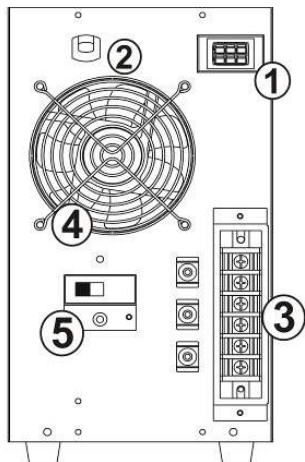

- ① UPS AC Output Connector
- ② UPS AC Input Connection Cable
- ③ Input/Output Terminal of PDU Module
- ④ Cooling Fan
- ⑤ Input Breaker

4.2 Rackmount model:

◆ **Main UPS Box**

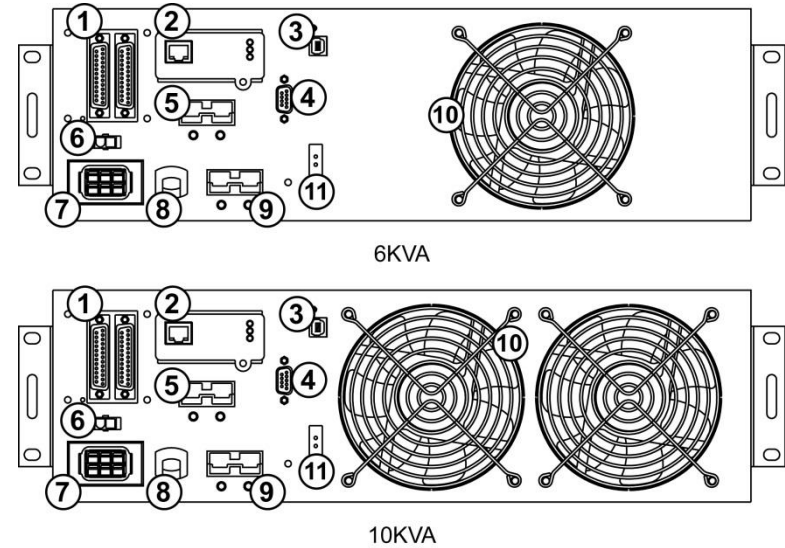

- ① Parallel Port
- ② Intelligent Slot
- ③ Communication Port: USB port
- ④ Dry Contact
- ⑤ JP1 & JP2
- ⑥ Bypass Switch Sensing Connector
- ⑦ UPS AC Input Connector
- ⑧ UPS AC Output Connection Cable
- ⑨ External Battery Connector: 240VDC
- ⑩ Cooling Fan
- ⑪ EPO Port

◆ **Individual PDU Module**

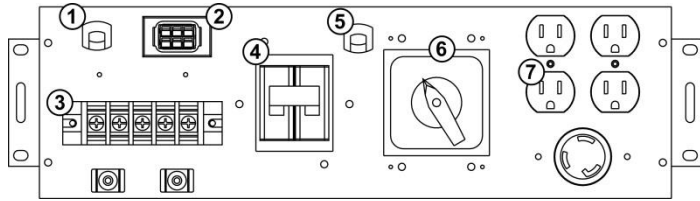

NEMA Type

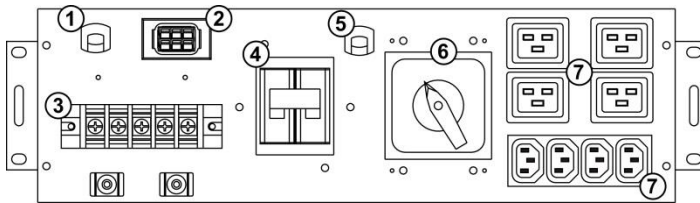

IEC Type

- ① UPS AC Input Connection Cable
- ② UPS AC Output Connector
- ③ Input/Output Terminal
- ④ Input Breaker
- ⑤ Bypass Switch Sensing Connection Cable
- ⑥ Maintenance Bypass Switch
- ⑦ Output Outlets

◆ **Isolation Transformer Box**

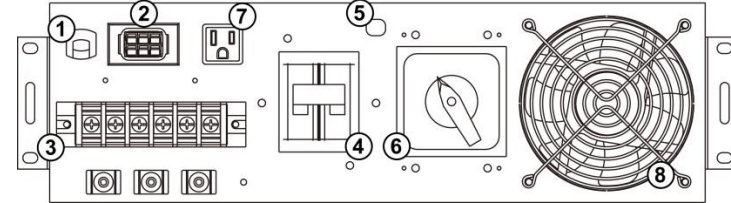

- ① UPS AC Input Connection Cable
- ② UPS AC Output Connector
- ③ Input/Output Terminal
- ④ Input Breaker
- ⑤ Bypass Switch Sensing Connection Cable
- ⑥ Maintenance Bypass Switch
- ⑦ Output Outlets
- ⑧ Cooling Fan

◆ **Battery Bank Box**

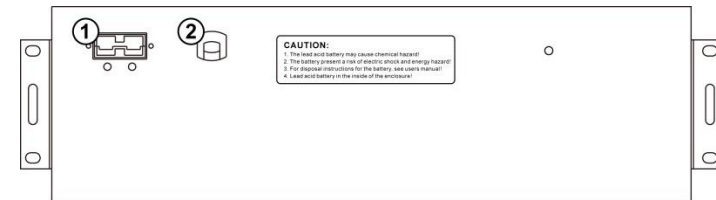

- ① External Battery Connector: 240VDC
- ② External Battery Connection Cable: 240VDC

5. Operation

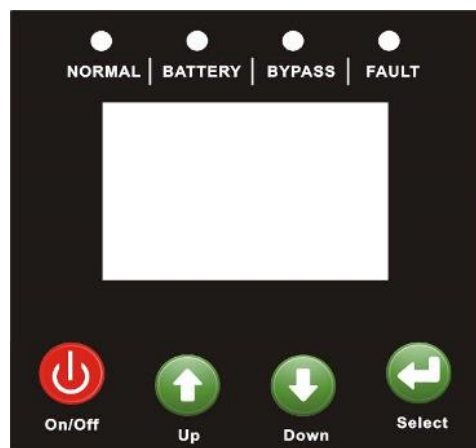

5.1 Display panel

The UPS has a four-button dot matrix LCD with dual color backlight. Standard back-light is used to light up the display with white text and a blue background. When the UPS has a critical alarm, the backlight changes the text to dark amber and the background to amber. Besides the LCD, the UPS has four colorized LEDs to provide more convenient information.



5.1.1 Control button functions table

Button Icon	Function	Illustration
	Power on	When the unit is no power and has connected with battery, press this button for >100ms & <1s to power on.
	Turn on	When the unit is powered on and is in Bypass mode, press this button for >1s to turn on.
	Turn off	When the unit has been turned on, press this button for >3s to turn off.

Button Icon	Function	Illustration
	Enter main menu	When displaying default UPS status summary screen, press this button for >1s to enter the main menu tree.
	Exit main menu	Press this button for >1s to exit the present menu to default system status display menu without executing a command or changing a setting.
	Scroll up	Press this button for >100ms & <1s to scroll up the menu option.
	Scroll down	Press this button for >100ms & <1s to scroll down the menu option.
	Enter next menu tree	Press this button for >100ms & <1s to select the present menu option, or enter next menu, but do not change any setting.
	Select one menu option	Press this button for >100ms & <1s to select the present menu option, or enter next menu, but do not change any setting.
	Confirm the present setting	Press this button for >1s to confirm the edited options and change the setting.

5.1.2 LED definition table

UPS state	Normal LED (Green)	Battery LED (Yellow)	Bypass LED (Yellow)	Fault LED (Red)
Bypass mode with no output			★	↑
Bypass mode with output			•	↑
Turning on	△	△	△	△
Line mode	•			↑
Battery mode	•	•		↑
HE mode	•		•	↑
Battery test mode	△	△	△	△
Fault mode			↑	•
Warning mode	↑	↑	↑	★

Remark :

- : Lightened constantly
- △ : #1-#4 Lightened circularly
- ★ : Flashing
- ↑ : Depended on the fault/warning status or other status

5.1.3 Alarm definition table

UPS condition	Buzzer status
Fault active	Continuous
Warning active	Beep every second
Battery output	Beep every 4 seconds, if battery low, buzzer Beep every second
Bypass output	Beep every 2 minutes
Overload	Beep twice every second

The UPS provides useful information about UPS itself, load status, events, measurements, identification, and settings through the front panel display. During powering on, the LCD would display the “WELCOME” logo for several seconds and then enter to the default page which shows the UPS status summary.

The display automatically returns to the default UPS status summary screen when no button has been pressed for 15 minutes.

On the UPS status summary screen it provides the following information:

- 1) Status summary, including mode and load.
- 2) Alarm status, including fault and warning information.
- 3) Battery and charger status, including battery voltage, charge level and charger status.
- 4) Running information of UPS running time.
- 5) Running information of parallel UPS (Rackmount UPS model available).

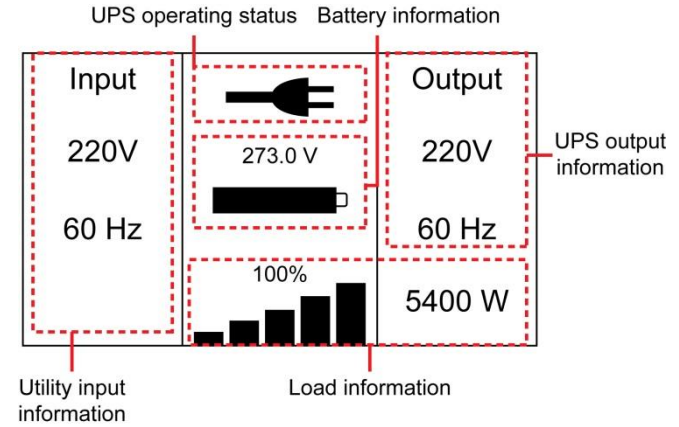

The more detailed operation of LCD is illustrated in the 5.4 chapter.

5.2 Operating Mode

The different graphic symbol could be displayed corresponding to current operating mode or status.

5.2.1 Line mode

Line mode means that the mains input is rectified/converted by the AC/DC section and then inverted to stable output by DC/AC section. In line mode, the output is clean and good to the loads. If the mains get abnormal, the UPS will transfer to battery mode without interrupt. The example of LCD display in Line mode is shown in the following diagram.

The symbol of operating in Line mode

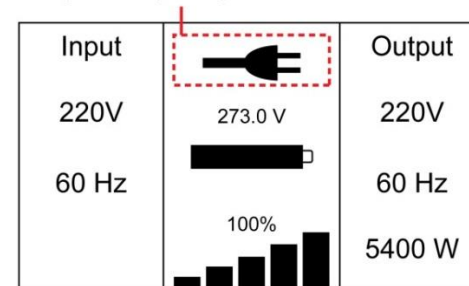

5.2.2 Battery mode

Battery mode means that the battery power goes through the DC/DC section to the inverter (DC/AC) and get a stable backup output when the mains input is not usable. If the mains input recovered, the UPS will transfer to line mode without interrupt. The example of LCD display in battery mode is shown in the following diagram.

The symbol of operating in Battery mode

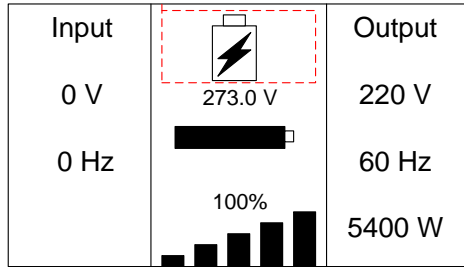

When the UPS is running in battery mode, the buzzer beeps once every 4 seconds.

5.2.3 Bypass mode

Bypass mode means that the UPS provides the power through the internal bypass way to load directly without any regulation. If the controller detects the mains is abnormal, it will shut off the output to protect the load. The UPS bypass voltage/frequency range could be set by communication software. However, UPS output power will be cut off if mains input range exceeds the setting value. The UPS bypass default output status (on/off) could also be set by communication software.

The UPS does not have the backup function when it is in bypass mode. The UPS will beep once every 2 minutes in bypass mode.

The LCD display in bypass mode with output is shown in the following diagram.

The symbol of operating in Bypass mode with output

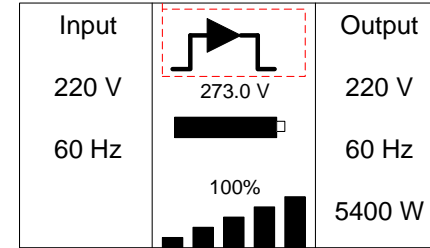

The LCD display in bypass mode without output is shown in the following.

The symbol of operating in Bypass mode without output

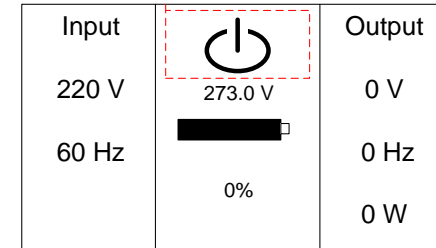

5.2.5 HE mode (High Efficiency mode)

It is also called economy mode. After the UPS is turned on, the power used by the load is supplied from the mains power via internal filter while the mains power is in normal range, so the high efficiency could be gained in the HE mode. Once the mains power is loss or abnormal, the UPS would transfer to Line mode or Battery mode and the load is supplied continuously.

The symbol of operating in ECO mode

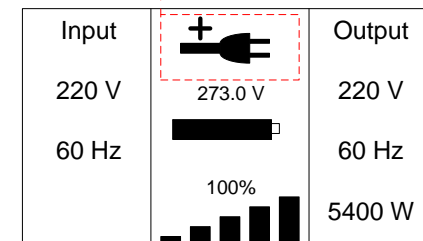

The function could be enabled through the LCD setting or the software, Winpower. It is attention that the transfer time of UPS output from HE mode to battery mode is about 10ms. But it is still too long for some sensitive load.

5.2.6 Converter mode

In converter mode, the UPS would free run with fixed output frequency (50Hz or 60Hz). Once the mains power is loss or abnormal, the UPS would transfer to battery mode and the load is supplied continuously.

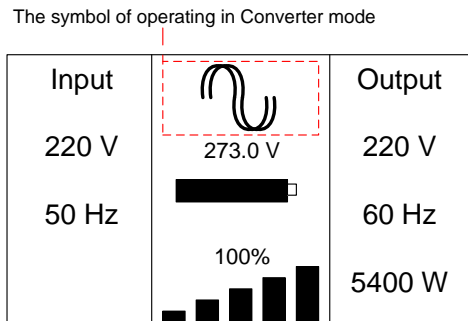

The function could be enabled through the LCD setting or the software, Winpower. The load should be derated to 60% in converter mode.

5.2.7 Warning

When the warning occurs, it illustrates that there are some abnormal problems during the operation of UPS. Normally the problems are not fatal and the UPS continues working, but they should be paid attention to, or the UPS may fail. The detailed warning table is shown in chapter of 7.

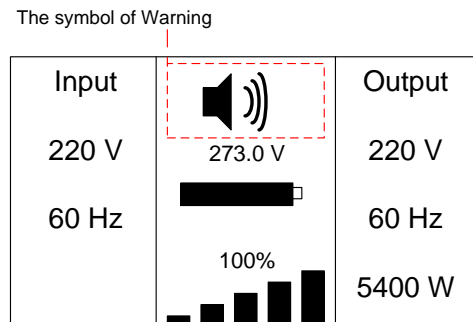

5.2.8 Fault

When the fault occurs, it illustrates that some fatal problems happened, the UPS would directly cut off the output or transfer to bypass, and keep alarming. The backlight of LCD would also turn to red. The detailed fault table is shown in chapter of 7.

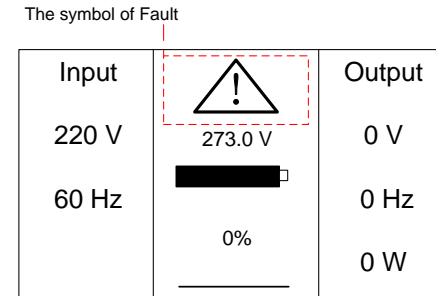

5.2.9 Other status

When the UPS is overload, the alarm will beep twice every second. Some unnecessary loads should be get rid of one by one to decrease the loads connected to the UPS less than 90% of its nominal power capacity.

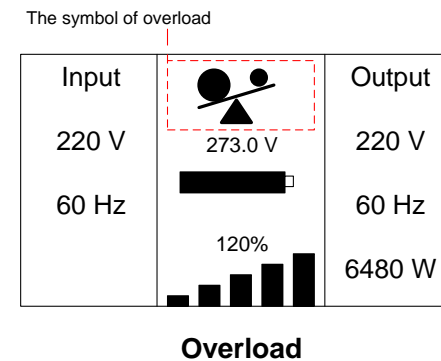

While doing the battery test, LEDs would be lighted circularly, and the symbol of battery test would be shown on the display.

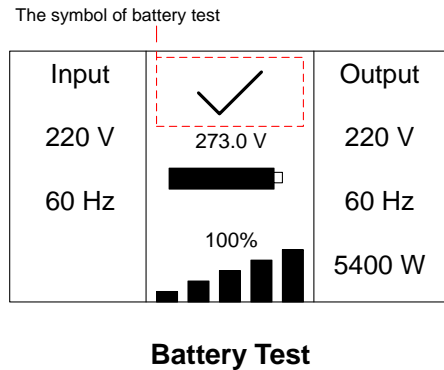

And if the battery status detected is battery disconnected, the symbol of battery failure would be shown and UPS would alarm.

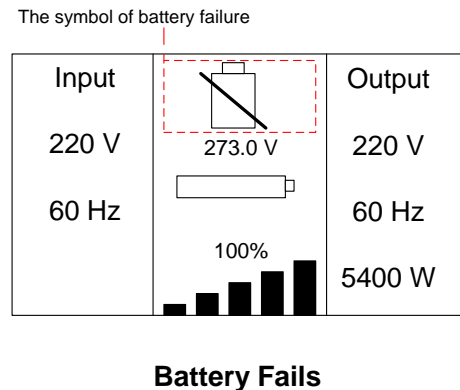

5.3 Turning on and turning off UPS



Attention: The UPS could only be turning on while connecting with the mains at the first time.

Attention: Please switch off the connected loads first before turning on the UPS, and switch on the loads one by one after the UPS is turned on. Switch off all of the connected loads before turning off the UPS.

5.3.1 Turning on UPS with mains

- 1) Check all the connection is correct.
- 2) Check and set input breaker in “ON” position. At this time the fan begins to rotate, LCD will show “WELCOME”. Then LCD will show the default UPS status summary screen after UPS finishing self-test.
- 3) By pressing  On/Off button continuously for more than 1 second, the buzzer will beep for 1s, UPS starts to turn on.
- 4) A few seconds later, the UPS turns into Line mode. If the mains power is abnormal, the UPS will transfer to Battery mode without output interruption of the UPS.

5.3.2 Turning on UPS without mains

- 1) Check all the connection is correct. Check and set input breaker in “ON” position.
- 2) By pressing  On/Off button continuously for more than 100ms, the UPS would be powered on. At this time the fan begins to rotate, LCD will show “WELCOME”. Then LCD will show the default UPS status summary screen after UPS finishing self-test.
- 3) By pressing  On/Off button continuously for more than 1s, the buzzer will beep for 1s, UPS starts to turn on.
- 4) A few seconds later, the UPS turns into Battery mode. If the mains power comes back, the UPS will transfer to Line mode without output interruption of the UPS.

5.3.3 Turning off UPS with mains

1) To turn off the inverter of UPS by pressing  On/Off button continuously for more than 3s and the buzzer will beep for 3s. The UPS will turn into Bypass mode at once.

2) When completing the above action, UPS output voltage is still present. In order to cut off the UPS output, simply cut off the mains power supply. A few seconds later, LCD display shuts down and no output voltage is available from the UPS output terminal or sockets.

5.3.4 Turning off UPS without mains



1) To power off the UPS by pressing  On/Off button continuously for more than 3s, and the buzzer will beep 3s. The UPS will cut off the output at once.

2) A few seconds later, LCD shuts down and no voltage is available from the UPS output.

5.4 LCD Operation

Except the default UPS status summary screen, the user could get more useful information about UPS current status, detailed various measurements, old events which ever occurred, UPS own identification, and could change the settings to fit the user own requirements, optimize the function of UPS.

5.4.1 The main menu

In the default UPS status summary screen, when pressing  or  <1s, the detailed information about alarm, battery would be shown.

In the default UPS status summary screen, when pressing  >1s, the display would enter main menu tree.

The main menu tree includes six branches: UPS status menu, event log menu, measurement menu, control menu, identification menu, setting menu.

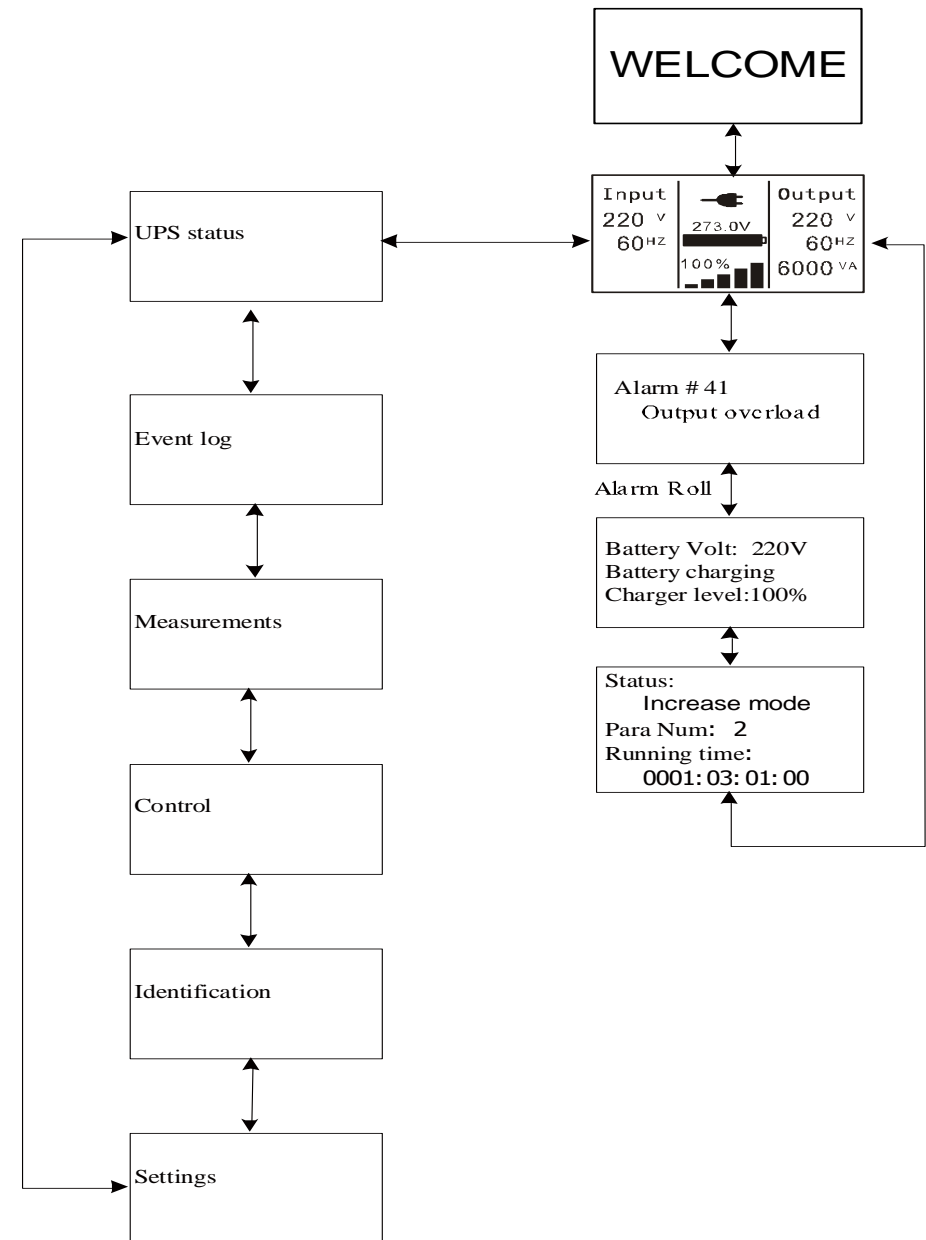

Measurement Menu Tree

5.4.2 The UPS status menu

By pressing  on the menu of “UPS status”, the display would enter the next UPS status menu tree.

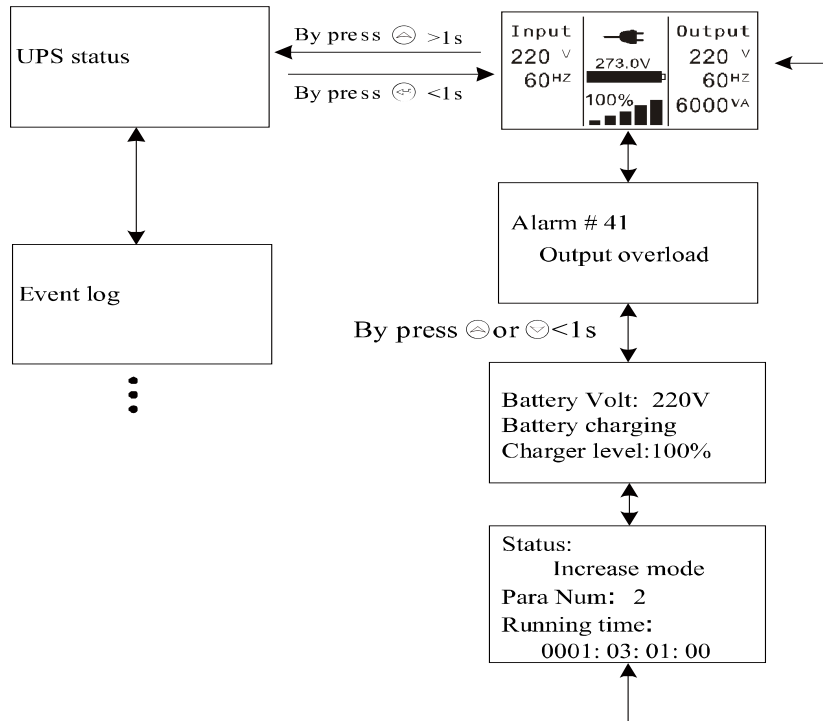

The content of UPS status menu tree is same as the default UPS status summary menu.

By pressing  >1s, the display would return the last main menu tree.



5.4.3 The event log menu

By pressing  on the menu of “Event log”, the display would enter the next event menu tree.

All the old event, alarm and fault have been recorded here. The information includes the illustration, the event code, and the operating time of UPS when the event happened. By press  or  <1s, all the event could be displayed one by one.

The max number of record is 50, when the number is larger than 50, the oldest one would be changed to the newest information.

By pressing  >1s, the display would return the last main menu tree.

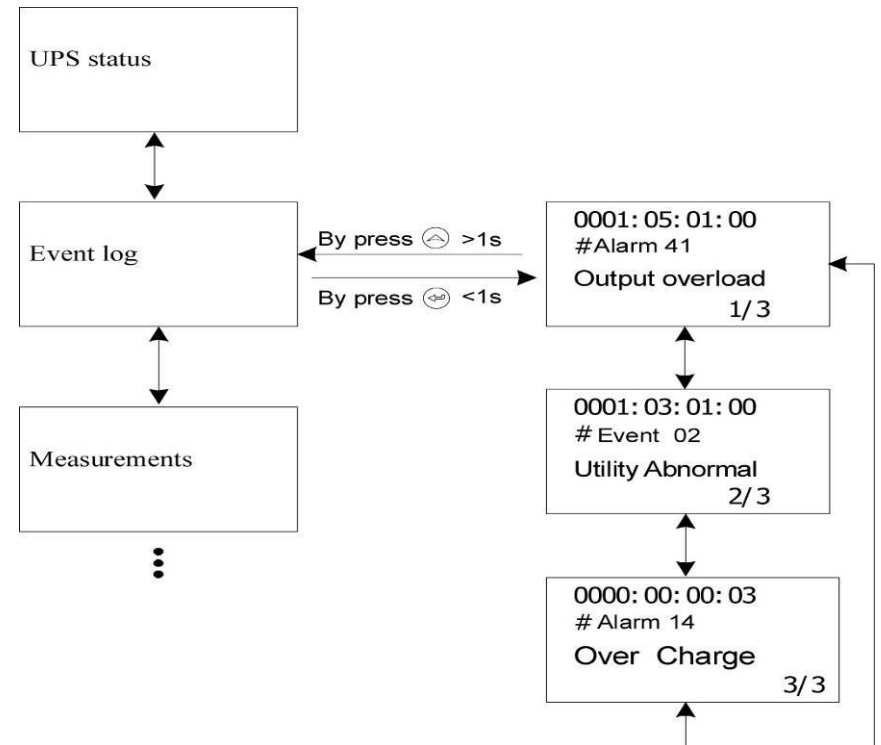

5.4.4 The measurement menu

By pressing  on the menu of “Measurement”, the display would enter the next measurement menu tree.

A lot of detailed useful information could be checked here, Ex. the output voltage and frequency, the output current, the load capacity, the input voltage and frequency, etc.

By pressing  >1s, the display would return the last main menu tree.

Note: Enter into setting menu and enable ‘Battery remaining time’. The backup time is for reference only.

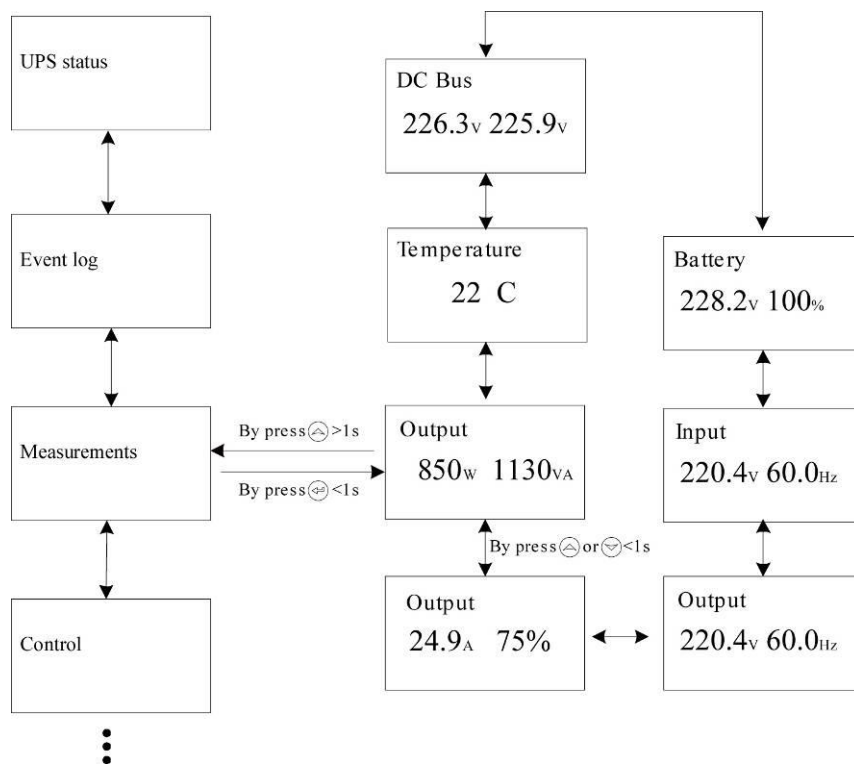

5.4.5 The control menu

Tower Model:

By pressing  on the menu of “Control”, the display would enter the next control menu tree.

1) Clear EPO status: Once EPO status is enabled, the UPS output would be cut off. To recover to normal status, first EPO connector should be closed, and enter this menu to clear EPO status, then UPS would stop alarm and recover to Bypass model. And UPS needs be turned on by manual operation.

2) Reset fault status: When fault occurs, UPS would keep in Fault mode and alarm. To recover to normal status, enter this menu to reset error status, then UPS would stop alarm and recover to Bypass mode. And the reason of fault should be checked and deleted before UPS is turned on again by manual operation.

3) Restore factory settings: All the settings would be recover to default factory settings. It could only be done in Bypass mode.

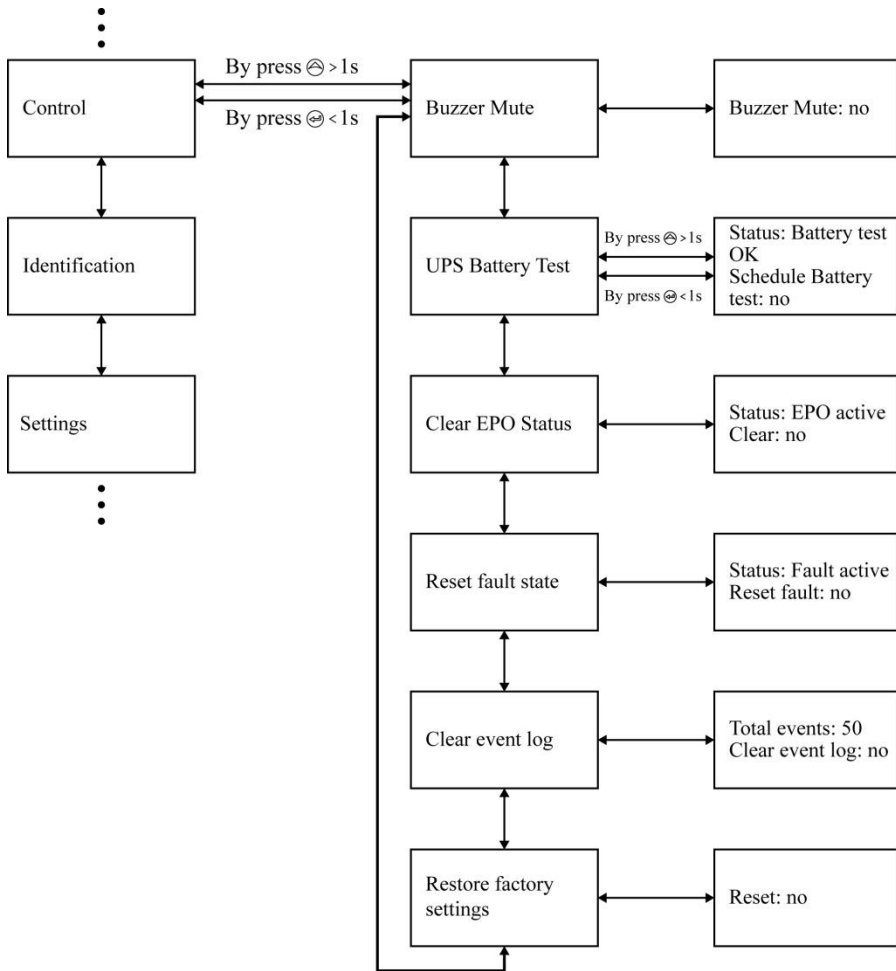

Rackmount Model:

By pressing \ominus on the menu of “Control”, the display would enter the next control menu tree.

- 1) Single UPS turn off: It is one command to turn off one UPS which is operated currently in a parallel system, and other UPSs continue working to supply the load in the parallel system.
- 2) Single UPS battery test: It is one command to control one UPS which is operated currently in a parallel system to do the battery test singly, and other UPSs do not do the battery test.
- 3) Parallel UPS battery test: It is one command to control all UPS in a parallel system to do the battery test at the same time.
- 4) Clear EPO status: Once EPO status is enabled, the UPS output would be cut off. To recover to normal status, first EPO connector should be closed, and enter this menu to clear EPO status, then UPS would stop alarm and recover to Bypass model. And UPS needs be turned on by manual operation.
- 5) Reset fault status: When fault occurs, UPS would keep in Fault mode and alarm. To recover to normal status, enter this menu to reset error status, then UPS would stop alarm and recover to Bypass mode. And the reason of fault should be checked and deleted before UPS is turned on again by manual operation.
- 6) Restore factory settings: All the settings would be recover to default factory settings. It could only be done in Bypass mode.

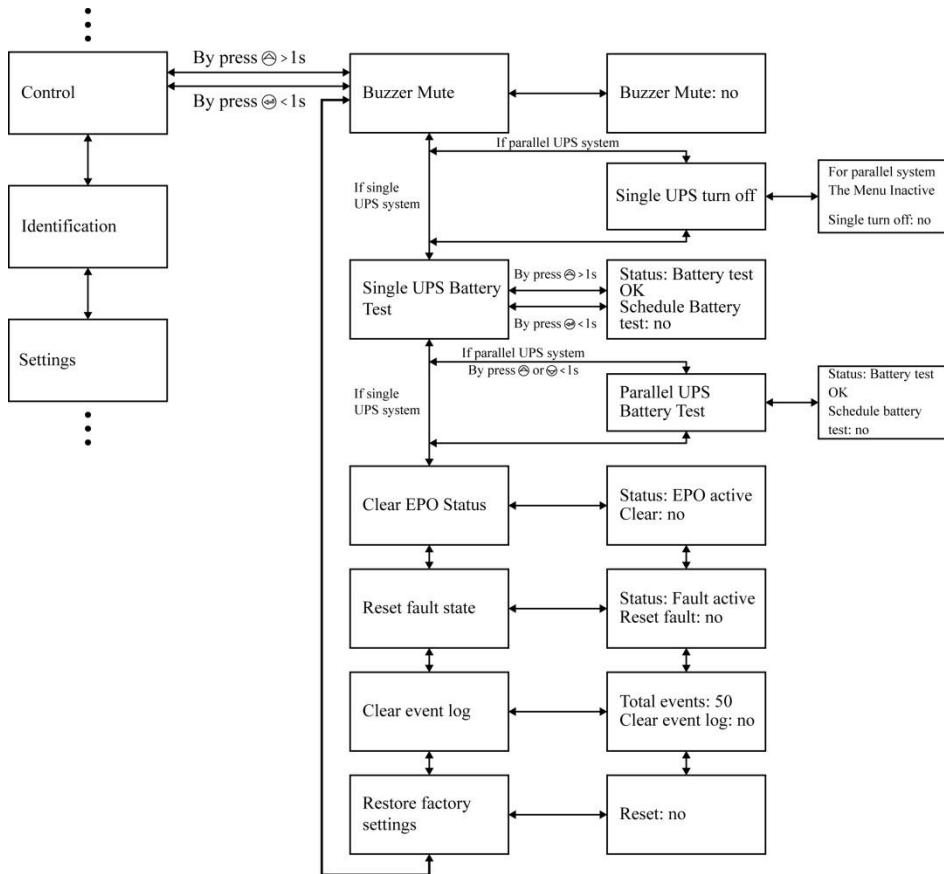

Example: clear EPO status

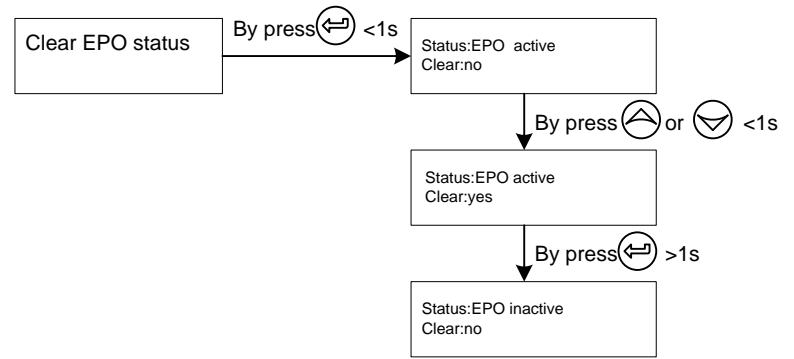

Note: First make sure the EPO signal is inactive or the LCD will show below information and the EPO active status couldn't be cleared.

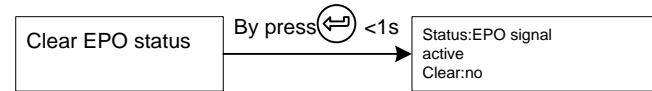

5.4.6 The identification menu

By press \leftarrow on the menu of "Identification", the display would enter the next identification menu tree.

The identification information includes UPS serial number, firmware serial number, model type, would be shown here.

By press \uparrow >1s, the display would return the last main menu tree.

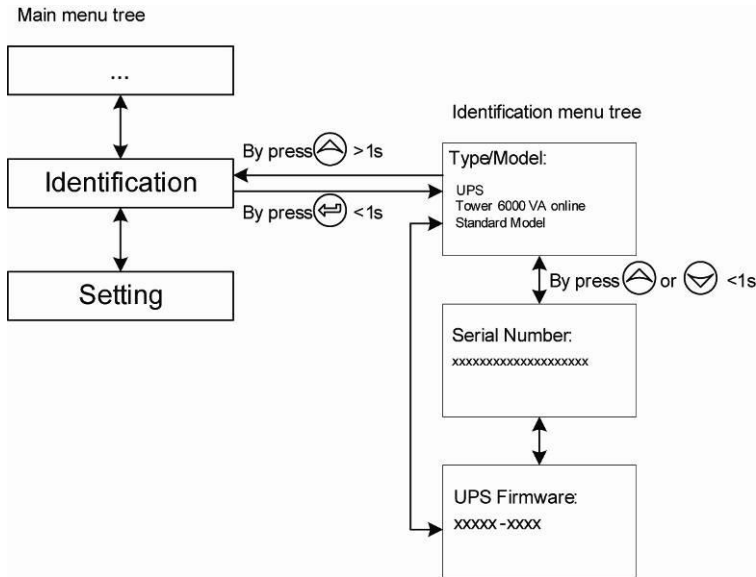

5.4.7 The setting menu

Please contact your local distributor for further information before using the settings. Some settings would change the specification, and some settings would enable or disable some functions. The unsuitable option set by user may result in potential failures or protecting function loss, even directly damage the load, battery or UPS.

Note:

- 1) The most of settings could only be done while UPS is in Bypass mode.
- 2) Please enable 'Battery remaining time', and press \leftarrow to 'The measurement menu'. Then the battery backup time can be found.

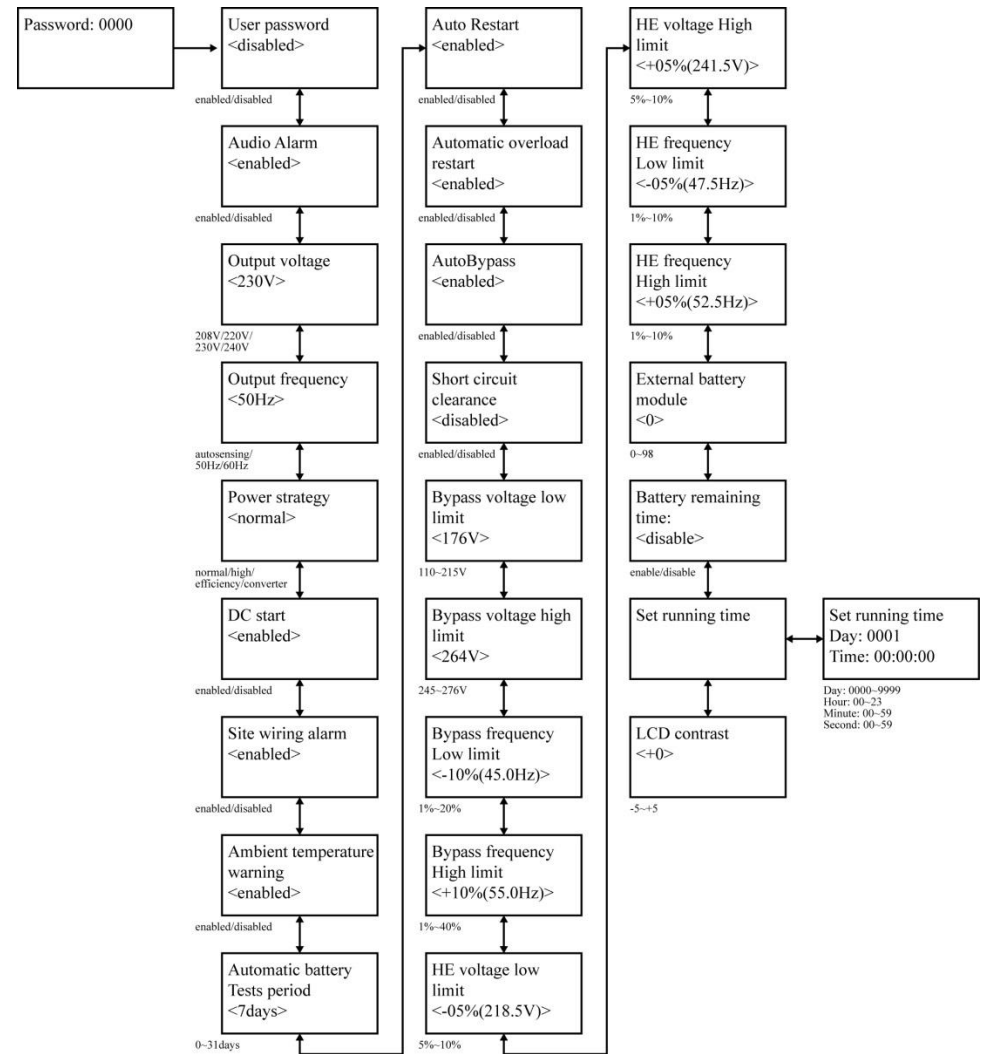

By press \leftarrow on the menu of "Identification", the display would enter the next setting menu tree if "User password" is disabled. If "User password" is enabled, the user should enter the password by press \uparrow , \downarrow , and \leftarrow , then enter the next setting menu tree.

Submenu item	Optional Values	Default value
User password	enabled/disabled	disabled
Audio alarm	enabled/disabled	enabled
Rated output voltage	208/220/230/240V	230V
Output frequency	autosensing/50/60Hz	autosensing
Power strategy	normal/high efficiency/ converter	normal
DC start	enabled/disabled	enabled
Site wiring fault alarm	enabled/disabled	enabled
Ambient temperature warning	enabled/disabled	enabled
Automatic battery tests period	0-31days	7days
Auto Restart	enabled/disabled	enabled
Automatic overload restart	enabled/disabled	enabled
AutoBypass	enabled/disabled	enabled
Short circuit clearance	enabled/disabled	disabled
Bypass voltage low limit	110~215V	176V
Bypass voltage high limit	245~276V	264V
Bypass frequency low limit	1%~10%	10%
Bypass frequency high limit	1%~10%	10%
HE voltage low limit	1%~10%	5%
HE voltage high limit	1%~10%	5%
HE frequency low limit	1%~10%	5%
HE frequency high limit	1%~10%	5%
Battery quantity	19/20/21	20
Set running time	Day:hour:minute:second 0000:0000:00~9999:23:59:59	Running time
LCD contrast	-5~+5	0

- 1) Password is USER when enabled.
- 2) Read the chapter of 6.1 and 6.2, before using high efficiency or converter function.
- 3) Ensure the real battery quantity is same as the setting, or the batteries would be damaged permanently.

Example: set rated output voltage value

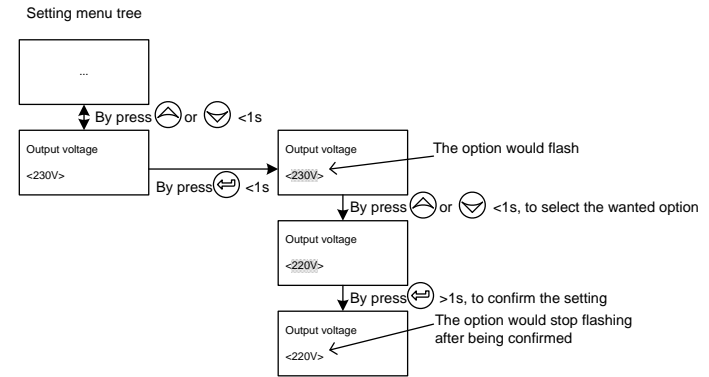

5.5 Remove main UPS from UPS system for maintenance

5.5.1 Tower Model:

1) Input/Output: 1P2W+G, 208/220/230/240VAC

Step 1: Please turn off UPS completely and disconnect cable①, cable②, cable③.

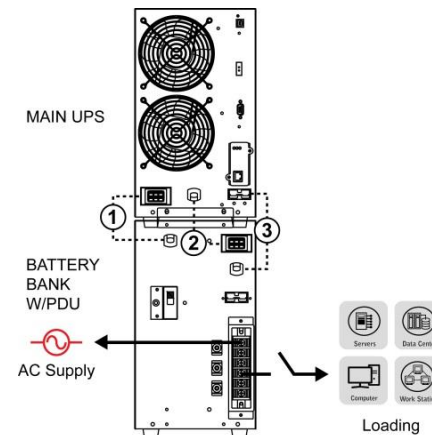

Step 2: Main UPS box can be sent to repair service. During UPS maintenance, you can connect UPS AC input connection cable to UPS AC output connector, refer to below cable①. Turn on input breaker of mains to supply power to loadings.

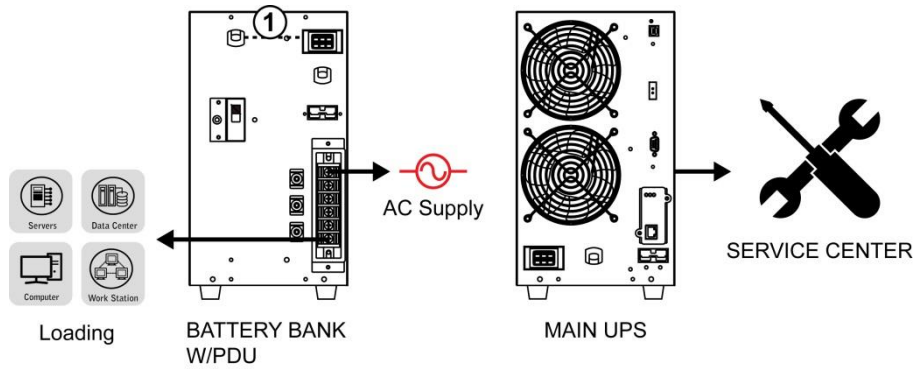

Step 3: When UPS is returned from repair service, please connect cable ①, cable ②, cable ③ of step 1. Make sure all cables are firmly connected.

2) Input: 1P2W+G, 220/230/240VAC; Output: 1P3W+G, 110/220VAC or 115/230VAC or 120/240VAC

Step 1: Please turn off UPS completely and disconnect cable ①, cable ②, cable ③.

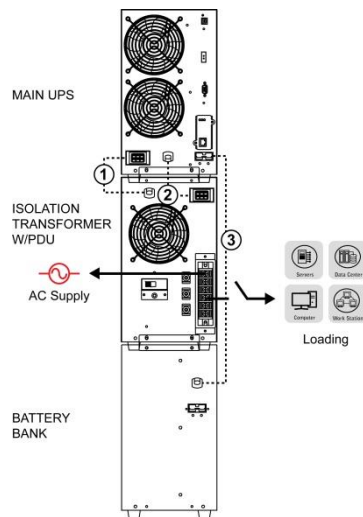

Step 2: Main UPS box can be sent to repair service. During UPS maintenance, you can connect UPS AC input connection cable to UPS AC output connector, refer to below cable ①. Turn on input breaker of mains to supply power to loadings.

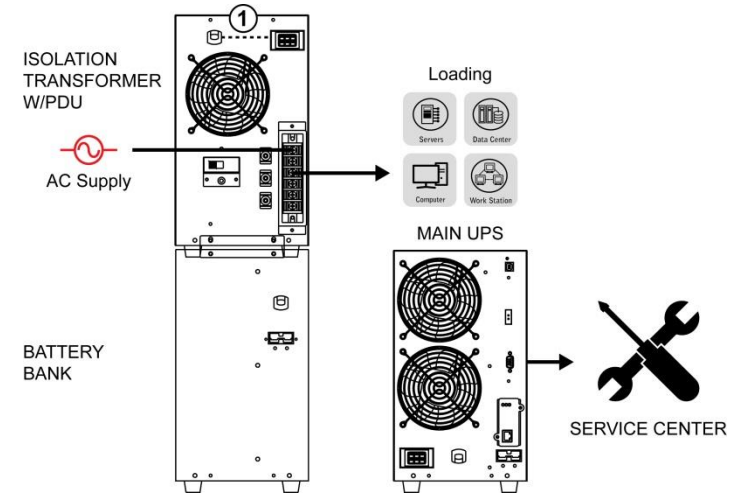

Step 3: When UPS is returned from repair service, please connect cable ①, cable ②, cable ③ of step 1. Make sure all cables are firmly connected.

5.5.2 Rackmount Model:

1) Input/Output: 1P2W+G, 208/220/230/240VAC

Step 1: Please press "OFF" button to switch UPS into bypass mode, then change over the maintenance bypass switch of PDU module from "INV." to "MAINT.", and turn off the input breaker of mains. Disconnect cable ①, cable ②, cable ③, cable ④, cable ⑤

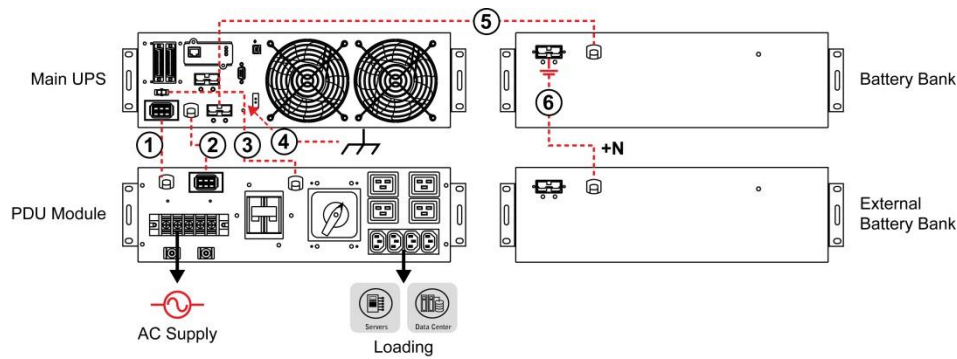

Step 2: Main UPS box can be sent to repair service. The load connected on PDU module will continuously be supplied by AC mains.

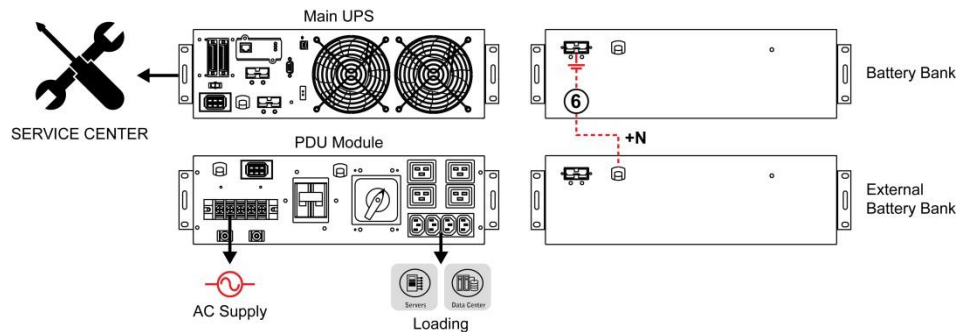

Step 3: When UPS is returned from repair service, please connect cable ①, cable ②, cable ③, cable ④, cable ⑤ of step 1. Make sure all cables are firmly connected, and then turn on the input breaker of mains and change over the maintenance bypass switch from “MAINT.” to “INV.”, lastly press “ON” button to turn on the UPS.

2) Input: 1P2W+G, 220/230/240VAC; Output: 1P3W+G, 110/220VAC or 115/230VAC or 120/240VAC

Step 1: Please press “OFF” button to switch UPS into bypass mode, then change over the maintenance bypass switch of Isolation Transformer box from “INV.” to “MAINT.”, and turn off the input breaker of mains. Disconnect cable ①, cable ②, cable ③, cable ④, cable ⑤

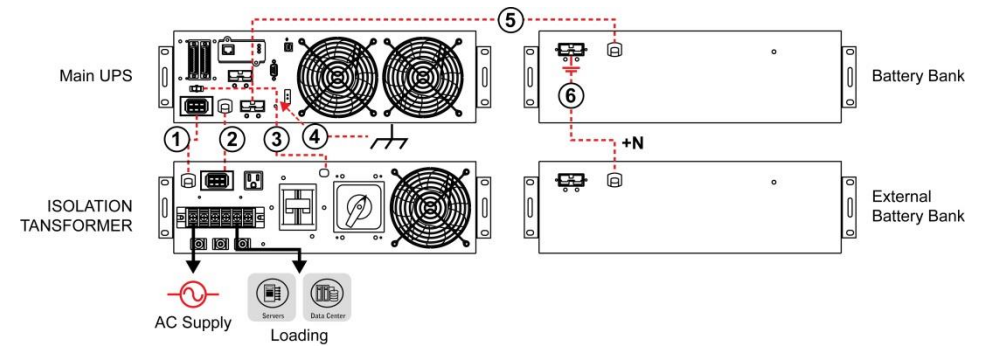

Step 2: Main UPS box can be sent to repair service. The load connected on Isolation Transformer box will continuously be supplied by AC mains.

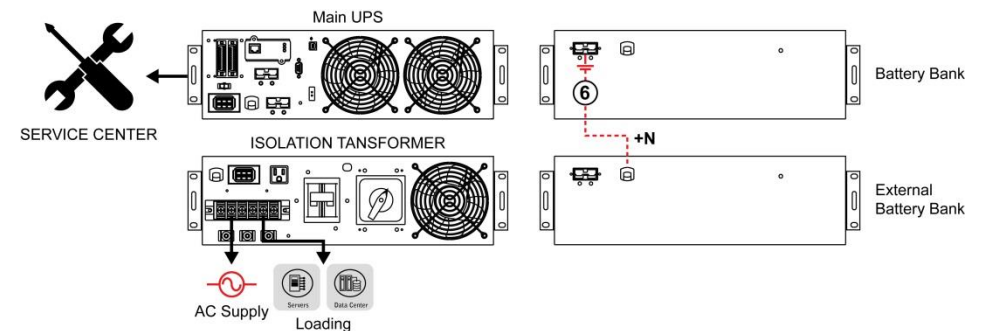

Step 3: When UPS is returned from repair service, please connect cable ①, cable ②, cable ③, cable ④, cable ⑤ of step 1. Make sure all cables are firmly connected, and then turn on the input breaker of mains and change over the maintenance bypass switch from “MAINT.” to “INV.”, lastly , lastly press “ON” button to turn on the UPS.

6. Special Functions

The series UPS has some special functions, which could satisfy some special application of users. And the functions have own features, please contact your local distributor for further information before using the function.

6.1 HE (High Efficiency) function

6.1.1 Brief introduction of HE function

If HE function is set to enable, after the UPS is turned on, the power used by the load is directly supplied from the mains power via internal filter while the utility power is in normal range, so the high efficiency could be gained in HE mode. It is also called economy mode. Once the mains power is loss or abnormal, the UPS would transfer to Line mode or Battery mode and the load is supplied continuously.

The great virtue is overall high efficiency ≥ 0.96 of UPS, to save power for user. But the disadvantage is 1) the load can not be protected as well as in Line mode, for the load is directly supplied from the mains; 2) the transfer time of UPS output from HE mode to Battery mode is about 10ms.

So the function is not suitable to some sensitive loads, and the region where the mains power is unstable.

6.1.2 Set the function

The function could be enabled through the LCD setting in Bypass mode .Enter the power strategy setting menu by following chapter of 5.4.7.

6.2 Converter function

6.2.1 Brief introduction of Converter function

In converter mode, the UPS would free run with fixed output frequency (50Hz or 60Hz). Once the mains power is loss or abnormal, the UPS would transfer to Battery mode and the load is supplied continuously.

The great virtue is the output frequency is fixed, which is required by some very sensitive loads.

But the disadvantage is the load capacity of UPS should be derated to 60% in converter mode.

6.2.2 Set the function

The function could be enabled through the LCD setting in Bypass mode. Enter the power strategy setting menu by following chapter of 5.4.7.

6.3 Parallel function (Rackmount model available)

6.3.1 Brief introduction of the redundancy

N+X is currently the most reliable power supply structure. N represents the minimum UPS number that the total load needs, X represents the redundant UPS number, i.e. the fault UPS number that the system can handle simultaneously. When the X is larger, the reliability of the power system is higher. For occasions where reliability is highly depended on, N+X is the optimal mode. As long as the UPS is equipped with parallel cables, up to 4 UPSs can be connected in parallel to realize output power sharing and power redundancy

6.3.2 Parallel installation and operation



➤ How to install a new parallel UPS system:

- 1) Before installing a new parallel UPS system, user need to prepare the input

and output wires, the output breaker, and the parallel cable.

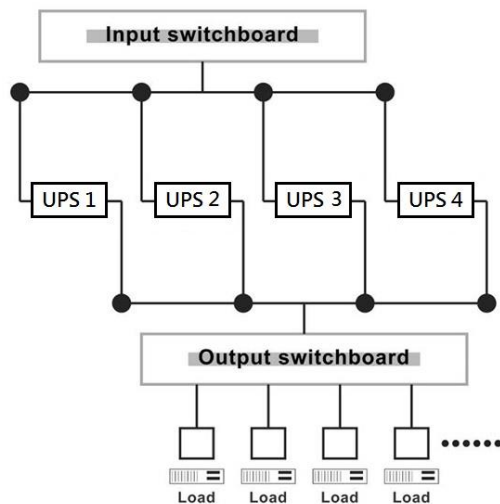
- 2) Users need to use a standard 25-pin communication cable, which should have 25 cores, corresponding stitches and shield, as the UPS parallel cable. The length of the parallel cable is appropriate to be less than 3m.
- 3) Remove the cover plate of the parallel port on the UPS, connect each UPS one by one with the parallel cable, and re-screw the parallel port cover which is supplied in the accessories.
- 4) Connect the output wires of each UPS to an output breaker panel.
- 5) Disconnect the Jumper on JP1 and JP2 of the terminal block first, and connect each output breaker to a main output breaker and then to the loads.
- 6) Each UPS need an independent battery pack.
- 7) The distance between the UPSs in parallel and the breaker panel is required to be less than 20 meters. The difference between the wires of input and output of the UPSs is required to be less than 20%.
- 8) Please refer to the wiring diagram in the following diagram.



- 9) Do not switch on the output breaker of each UPS, switch on the input breaker of the each UPS, the UPS should work in bypass with output, observe their display to check if there are any warning or fault information, measure the output voltage of each UPS separately to check if the voltage difference between them is less than 1V. If the difference is more than 1V, check the wiring.
- 10) Press the  button of one UPS, each UPS would start to turn on, all the UPSs would transfer to the INV mode together. Measure the output voltage of each UPS separately to check if the voltage difference between them is less than 0.5V. If the difference is more than 0.5V, the UPSs need to be regulated.
- 11) Press the  button of one UPS, each UPS would start to turn off and transfer to the Bypass mode, switch on the output breaker of each UPS to parallel all the output of UPSs together
- 12) Press the  button of one UPS, each UPS would start to turn on, after turning on, the UPSs should work parallel in the Line mode.

➤ **How to join a new UPS to a parallel system:**

- 1) First the parallel system must be installed one main maintenance bypass switch or static switch.
- 2) Regulate the output voltage of the new UPS separately: check if the output voltage difference between the new UPS and the parallel system is less than 0.5V.
- 3) Ensure the bypass of the parallel system is normal and the bypass setting is "enable", remove the cover plate of maintenance bypass switch on the rear panel of each UPS, the UPS system would transfer to bypass automatically, set the own maintenance bypass switch of each UPS from "INV." to "MAINT."
- 4) Set the main maintenance bypass switch or static switch from "INV." to "MAINT.", switch off the main output breaker and the main input breaker, the UPSs would shut down.

5) Ensure the UPSs shut down totally, add the new UPS and reinstall the new UPS parallel system by step 1) to 8) of chapter 6.3.2.

6) Switch on the main input breaker and the main output breaker, and set the main maintenance bypass switch or static switch from “MAINT.” to “INV.”, then set the UPS own maintenance bypass switch from “MAINT.” to “INV.” and screw the cover plate of maintenance bypass switch back again. Press the  button of one UPS, each UPS would start to turn on, after turning on, the UPSs should work parallel in the Line mode.

➤ **How to remove a single UPS from a parallel system:**

1) First the parallel system must be installed one main maintenance bypass switch or static switch.

2) Ensure the bypass is normal and the bypass setting is “enable”, remove the cover plate of maintenance bypass switch on the rear panel of each UPS, the UPS system would transfer to bypass automatically, set the own maintenance bypass switch of each UPS from “INV.” to “MAINT.”.

3) Set the main maintenance bypass switch or static switch from “INV.” to “MAINT.”, switch off the main output breaker and the main input breaker, and the UPSs would shut down.

4) Ensure the UPSs shut down totally, remove the wanted UPS and, if necessary, reinstall the new UPS parallel system by step 1) to 8) of chapter 6.3.2.

5) If the removed UPS or the remained UPS will be used in a stand-alone mode, then JP1 and JP2 on the terminal block should be connected with a short connection wire.

6) Switch on the main input breaker and the main output breaker, and set the main maintenance bypass switch or static switch from “MAINT.” to “INV.”, then set the UPS own maintenance bypass switch from “MAINT.” to “INV.” and screw the cover plate of maintenance bypass switch back again.

Press the  button of one UPS, each UPS would start to turn on, after turning on, the UPSs should work parallel in the Line mode.

7. Trouble Shooting

If the UPS system does not operate correctly, first check the operating information on the LCD display. Please attempt to solve the problem using the table below. If the problem still persists, consult your dealer.

7.1 Trouble shooting according to warning indication

Problem	Possible cause	Solution
Read EEPROM Error	UPS internal fault.	Consult dealer.
EPO Active	EPO connector is open.	Check the EPO connector status.
On Maintain Bypass	Maintain bypass switch is open.	Check the maintain bypass switch status.
IP Soft-start Failed	UPS internal fault.	Consult dealer.
Site Wiring Fault	Phase and neutral conductor at input of UPS are reversed.	Reverse mains power wiring.
Battery Disconnect	Battery pack is not connected correctly.	Do the battery test to confirm. Check the battery bank is connected to the UPS. Check the battery breaker is turn on.
Battery Low	Battery voltage is low.	When audible alarm sounding every second, battery is almost empty.
Output Overload	Overload	Check the loads and remove some non-critical loads. Check if some loads are failed.
Fan Failure	Fan abnormal.	Check if the fan is running normally.
Charger Fail	The charge fails.	Consult dealer.
Battery Over Voltage	Battery voltage is higher than normal value.	Check if the battery quantity is right.

Problem	Possible cause	Solution
Over Charge	Battery is over charged.	The UPS will turn off the charger until the battery voltage is normal.
Model Pin Error	UPS internal fault.	Consult dealer.
Ambient Over Temperature	The ambient temperature is too high	Check the environment ventilation.
Heatsink Over Temperature	Inside temperature of UPS is too high.	Check the ventilation of UPS and the ambient temperature.
Ambient NTC abnormal	UPS internal fault.	Consult dealer.
IP Fuse Open	Input fuse break.	Check the input fuse status.

7.2 Trouble shooting according to warning indication (Available for rackmount model in parallel connection)

Problem	Possible cause	Solution
Para Cable Male Loss	The parallel cable is disconnected.	Check the parallel cable.
Para Cable Female Loss	The parallel cable is disconnected.	Check the parallel cable.
Para Bat Differ	The battery packs of some UPSs are disconnected.	Check if all the battery pack is connected.
Para Line Differ	The mains input of some UPSs is disconnected.	Check the building wiring and input cable. Check if the input breaker is closed. Ensure the UPSs are connected to same input source.
Para Work Mode Differ	There are different power strategy setting in parallel system.	The UPSs with different power strategy setting (Ex. one Line mode and one Converter mode) are forbidden to parallel.
Para Rate Power Differ	There are different UPSs in parallel system.	The UPSs with different capacity (Ex. one 6KVA and one 10KVA) are forbidden to parallel.
ECO In Para	HE function is enabled in parallel system.	HE function is forbidden in parallel system.

7.3 Trouble shooting according to fault indication

Problem	Possible cause	Solution
INV Overload Fault	Overload	Check the loads and remove some non-critical loads. Check if some loads are failed.
BYP Overload Fault	Overload	Check the loads and remove some non-critical loads. Check if some loads are failed.
Output Short Circuit	Output short circuit.	Remove all the loads. Turn off the UPS. Check if UPS output and loads is short circuit. Ensure short circuit is removed before turning on again.
Heatsink Over Temperature Fault	Inside temperature of UPS is too high.	Check the ventilation of UPS and the ambient temperature.
BUS Over Voltage	UPS internal fault.	Consult dealer.
BUS Under Voltage	UPS internal fault.	Consult dealer.
BUS Unbalance	UPS internal fault.	Consult dealer.
BUS Short	UPS internal fault.	Consult dealer.
BUS Softstart Fail	UPS internal fault.	Consult dealer.
INV Over Voltage	UPS internal fault.	Consult dealer.
INV Under Voltage	UPS internal fault.	Consult dealer.
INV Softstart Fail	UPS internal fault.	Consult dealer.
Negative Power Fault	The load is pure inductive and capacitive.	Remove some non-critical loads. Bypass supplies the load first, ensure there is no overload, then turn on UPS.
Fan Lock Fault	Fan blocked or disconnected over time.	Check the fan status.
Back Feed	Output voltage is returned to input.	Consult dealer.

7.4 Trouble shooting according to fault indication (Available for rackmount model in parallel connection)

Problem	Possible cause	Solution
Cable Male and Female Loss Fault	The parallel cable is disconnected.	Check the parallel cable.

7.5 Trouble shooting in else cases

Problem	Possible cause	Solution
No indication, no warning tone even though system is connected to mains power supply.	No input voltage.	Check the building wiring and input cable. Check if the input breaker is closed.
BYPASS LED light up even though the power supply is available.	Inverter not switched on.	Press On/Off button to turn on UPS.
BATTERY LED lights up, and audible alarm beep once every 4 seconds.	Input voltage and/or frequency are out of tolerance.	Check input power source. Check the building wiring and input cable. Check if the input breaker is closed.
Emergency supply period shorter than nominal value.	Batteries not fully charged / batteries defect.	Charge the batteries for at least 12 hours and then check capacity.

Please have the following information at hand before calling the After-Sales

Service Department:

- 1) Model number, serial number.
- 2) Date on which the problem occurred.
- 3) LCD/LED display information, Buzzer alarm status.

- 4) Mains power condition, load type and capacity, environment temperature, ventilation condition.
- 5) The information (battery capacity, quantity) of external battery pack.
- 6) Other information for complete description of the problem.

8. Battery Maintenance

Battery replacement should be performed by qualified personnel.

- 1) This series UPS only requires minimal maintenance. The battery used for standard models are value regulated sealed lead-acid maintenance free battery. These models require minimal repairs. The only requirement is to charge the UPS regularly in order to maximize the expected life of the battery. When being connected to the mains power, whether the UPS is turned on or not, the UPS keeps charging the batteries and also offers the protective function of overcharging and over-discharging.
- 2) The UPS should be charged once every 4 to 6 months if it has not been used for a long time.
- 3) In the regions of hot climates, the battery should be charged and discharged every 2 months. The standard charging time should be at least 12 hours.
- 4) Under normal conditions, the battery life lasts 3 to 5 years. In case if the battery is found not in good condition, earlier replacement should be made.
- 5) Replace batteries with the same number and same type of batteries.
- 6) Do not replace the battery individually. All the batteries should be replaced at the same time following the instructions of the battery supplier.
- 7) If the battery service life (3~5 years at 25°C ambient temperature) has been exceeded, the batteries must be replaced.

9. Communication Port

9.1 USB interface

The USB port is compliance with USB 1.1 protocol for its communication software.

9.2 Dry contact interface

This series UPS has independent dry contact interface. Please contact your local distributor for details. The following is the pin assignment and description of DB-9 connector.

Pin #	Description	I/O	Pin #	Description	I/O
1	UPS Fail	Output	6	Bypass	Output
2	Summary Alarm	Output	7	Battery Low	Output
3	GND	Input	8	UPS ON	Output
4	Remote Shutdown	Input	9	Line Loss	Output
5	Common	Input			

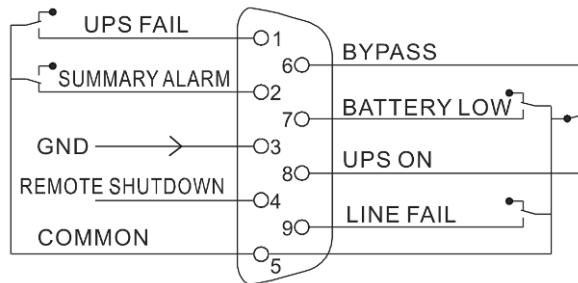

9.3 Intelligent slot

This series is equipped with an intelligent slot for other optional card to achieve remote management of the UPS through internet / intranet. Please contact your local distributor for further information.

10. Monitoring Software

10.1 Free software download – WinPower

WinPower is a UPS monitoring software, which provides user-friendly interface to monitor and control UPS. This unique software provides safely auto shutdown for multi-computer systems while power failure. With this software, users can monitor and control any UPS on the same LAN no matter how far from the UPS.

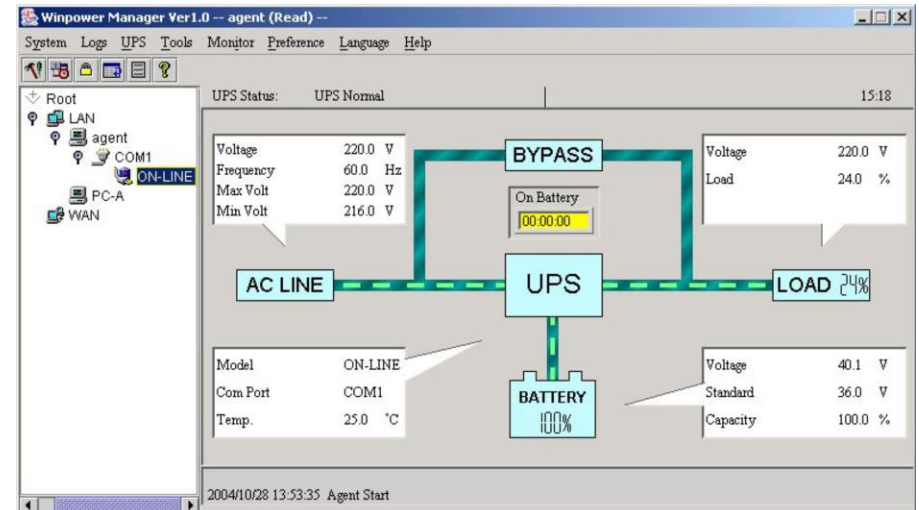

10.2 Installation procedure:

- 1) Go to the website: <http://www.ups-software-download.com/>
- 2) Choose the operation system you need and follow the instruction described on the website to download the software.
- 3) When downloading all required files from the internet, enter the serial No: **511C1-01220-0100-478DF2A** to install the software.
- 4) When the computer restarts, the WinPower software will appear as a green plug icon located in the system tray, near the clock.