

REV	DATE	MODIFICATION	修改内容	DRAWN
	2023/12/18			

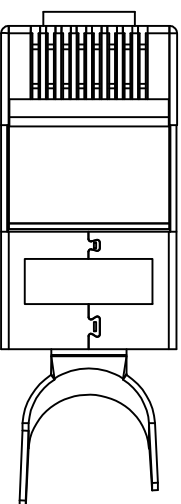
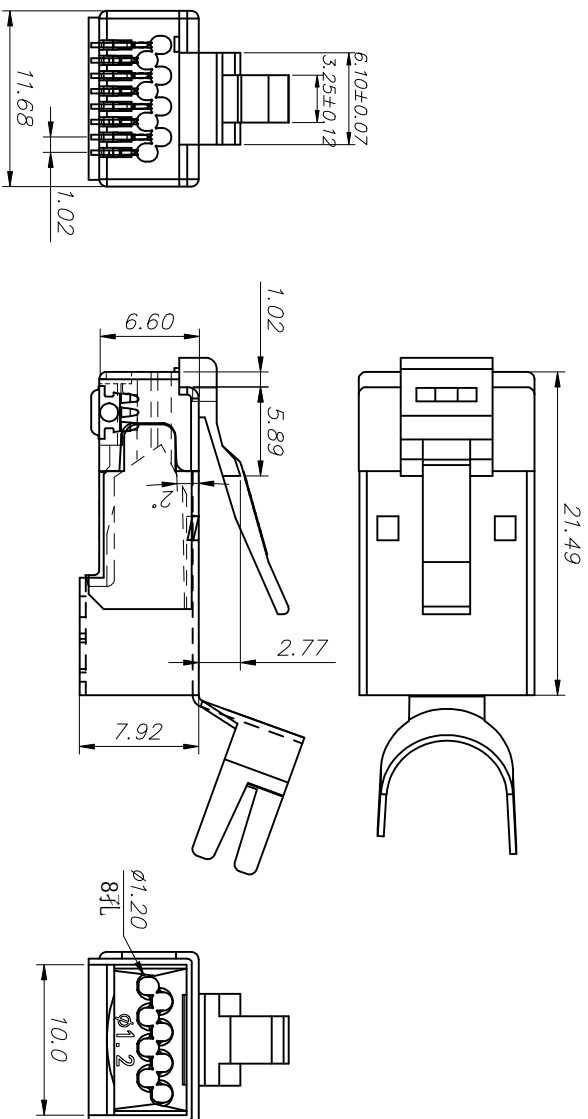

- SPECIFICATIONS**
- 1. ELECTRICAL:**  
 UL APPLICATIONS: 250 VOLTS AC MAX. AT 2 AMPS.  
 DIELECTRIC WITHSTANDING VOLTAGE: 1000 VOLTS AC. 60 SEC.  
 INSULATION RESISTANCE: 500 MQ.  
 CONTACT RESISTANCE: 20mΩ MAX.  
 OPERATING AMBIENT TEMPERATURE: -40°C ~ 70°C.
- 2. MECHANICAL:**  
 STRAIN RELIEF: 20POUND MIN.  
 DURABILITY: 1200 MATING CYCLES.
- 3. MATERIAL:**  
 HOUSING: POLYCARBONATE, UL 94V-0 OR UL 94V-2.  
 COLOR: TRANSPARENT OR OTHER COLOR ARE AVAILABLE.  
 CONTACT BLADE: COPPER ALLOY.  
 GOLD PLATING: 3u"-50u", ARE AVAILABLE.  
 SHIELDED SHELL: COPPER NICKEL ALLOY.
- 4. USAGE:**  
 SUITABLE FOR STRANDED & SOLID WIRE 22AWG ~ 26AWG.  
 (It can be used for the wire OD from Ø 1.05 ~ Ø 1.15)  
 规范
- 1. 电器特性:**  
 UL应用: 250 VOLTS AC. 最大 2 AMPS  
 耐电压: 1000 VOLTS AC. 60秒  
 绝缘电阻: 500 百万欧姆,  
 接触电阻: 小于 20 毫欧姆  
 工作环境温度: -40°C ~ 70°C.
- 2. 机械特性:**  
 拉力测试: 大于 20磅.  
 插拔测试: 大于 1200 次.
- 3. 材质:**  
 塑胶体: 聚碳酸酯, UL-94V-0 或 UL94V-2.  
 颜色: 透明, 或依客户需求  
 金片: 铜合金,  
 镀金厚度: 3u"-50u", 皆可提供.  
 铜外壳: 铜镍合金.
- 4. 适用线材:**  
 多股线 & 单股线, 22AWG ~ 26AWG 均适用.  
 (芯线直径: Ø1.05 ~ Ø1.15 均可适用)

客户产品图

**EXW** Excellence Wire Ind. Co., Ltd

DIMENSION IN mm (Inch)	材 质	材 质	图 号
TOLERANCE UNLESS OTHERWISE SPECIFIED	MATERIAL	PC	DWG NO. PLUG-621-0001

.X±0.20	.X±5°	名称	P8885.D050V2S1T-3Y(线孔1.2通孔, 配1.5支架, 铁壳大线槽通孔, 2468埋超短片)
.XX±0.10	.XX±2°	TITLE	

审核 APPROVAL	核 对 CHECKED	制 图 DRAWN	比 例 SCALE	张 数 SHEET	更 改 REV
Carline	Zach	Cathlyli	2/1	1/1	A

BLADE:	E	EB	Y	YB	Z	A	AE	AB	ZD
Drawing									
Mark					✓				✓
GOLD PLATING	3Mu"	3u"	6u"	15u"	30u"	50u"			
Mark					✓				✓
							CABLE TYPE	ROUND	FLAT
							Mark	✓	

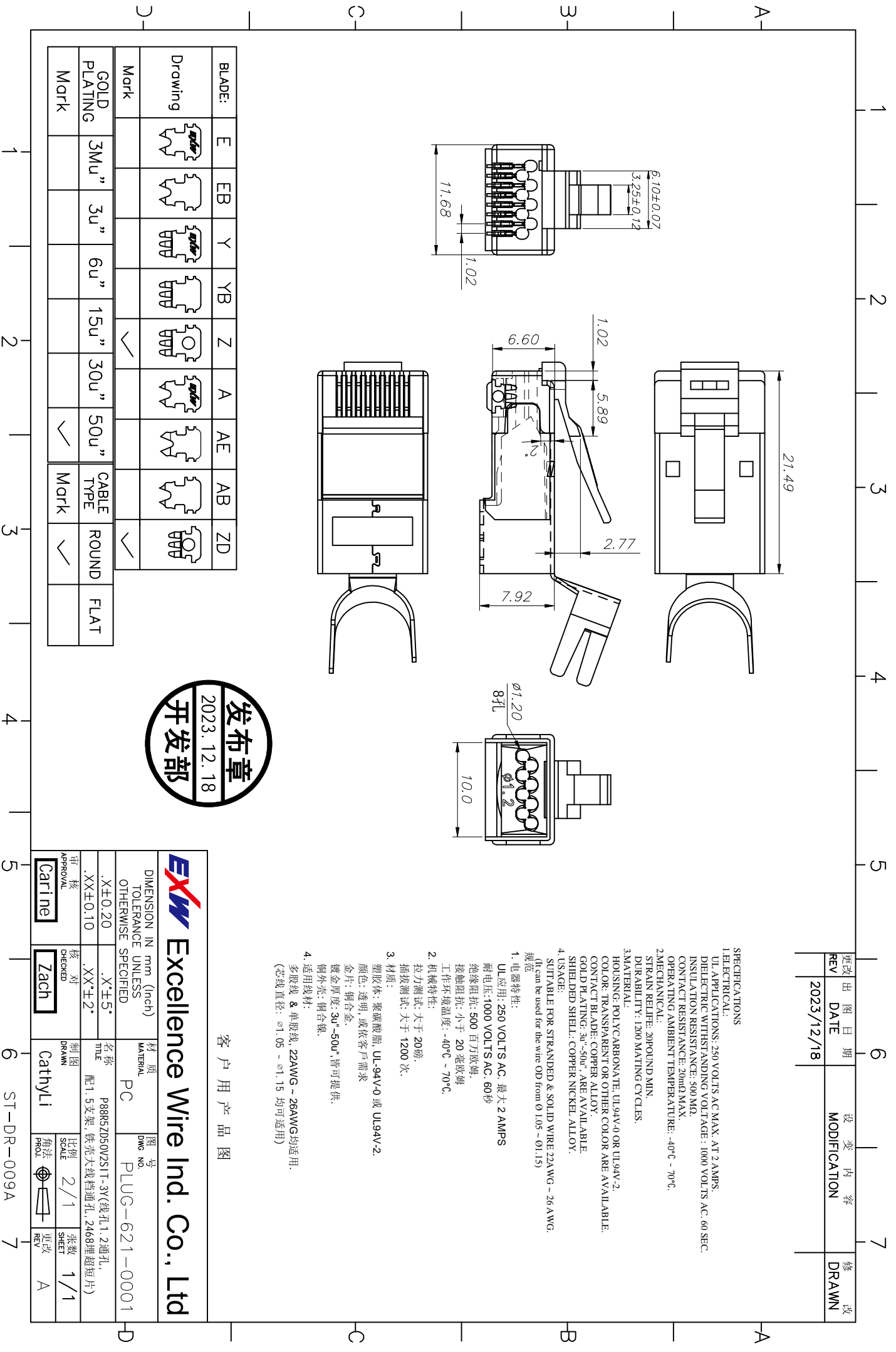

更改 REV	出图日期 DATE	变更内容 MODIFICATION	修改 DRAWN
D	2017/06/15	外形更改 Δ	Zach

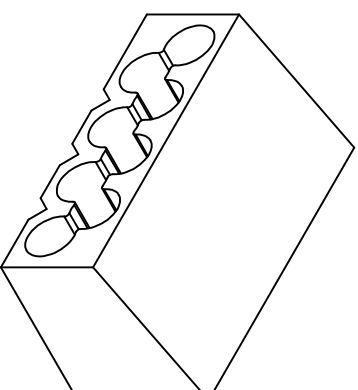
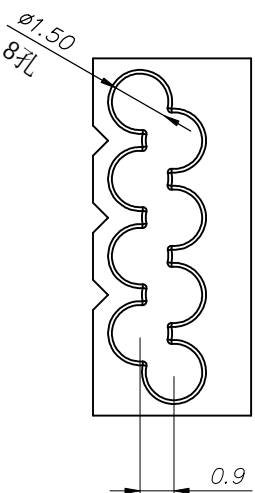
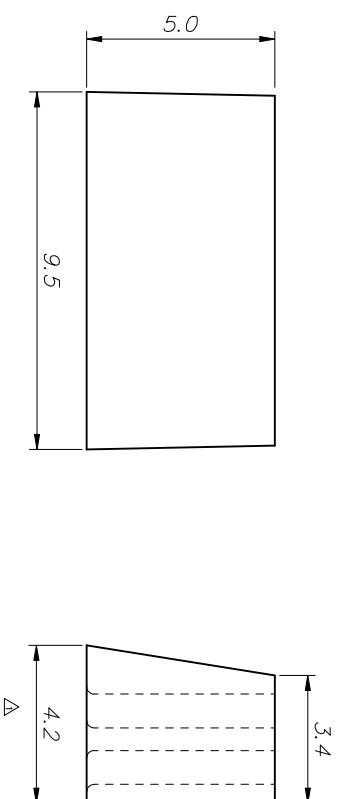

客户用产品图

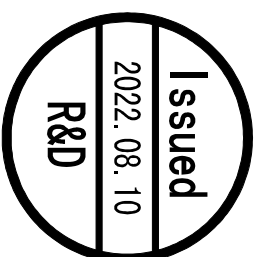

<b>EXW</b> Excellence Wire Ind. Co., Ltd		材 质 MATERIAL	图 号 DWG NO
DIMENSION IN mm (Inch)		PC	PLUG INSERT-040A
TOLERANCE UNLESS OTHERWISE SPECIFIED			
X ± 0.20	X ° ± 5 °	名称 TITLE	3Y双排支架(线孔1.5)
.XX 0.10	.XX ° ± 2 °	制 图 DRAWN	Zach
审 核 APPROVAL	核 对 CHECKED	比 例 SCALE	5/1
Gatine	Zach	张 数 SHEET	1/1
		角 法 PROJ	更改 REV
			D